

63" MAGNUS RESIN FREESTANDING TUB

Cat. No.
RTOVN63-OF



L: 63"
W: 35-1/2"
H: 22"

Water depth: 18" to top of tub
Water depth: 14-1/4" to overflow

The following is recommended for RTOVN63-OF soaking tubs:

- Faucets: part #7082 or 7088
- Rigid, freestanding supplies: part #4502
- Freestanding, filler part #7901, 7922 or 7952

(Does not need bath supplies)

Gallon Capacity: 91
Shipping Weight: 428 lbs.
Empty Weight: 328 lbs.
Filled Weight: 1,088 lbs

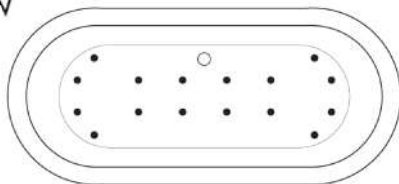

(Air jet configuration if system is added, more info on page 2.)

Features:

- ▶ Poly-resin blend is the same color throughout
- ▶ 1" thick at rim
- ▶ Available in Matte or Gloss finish
- ▶ No faucet holes
- ▶ Built-in overflow slot
- ▶ Includes white pop-up drain
- ▶ Tub is thoroughly inspected before shipment
- ▶ **New:** Air jet system now available, more info on page 2

Tub Colors:

WH Matte White
WHGL GlossWhite

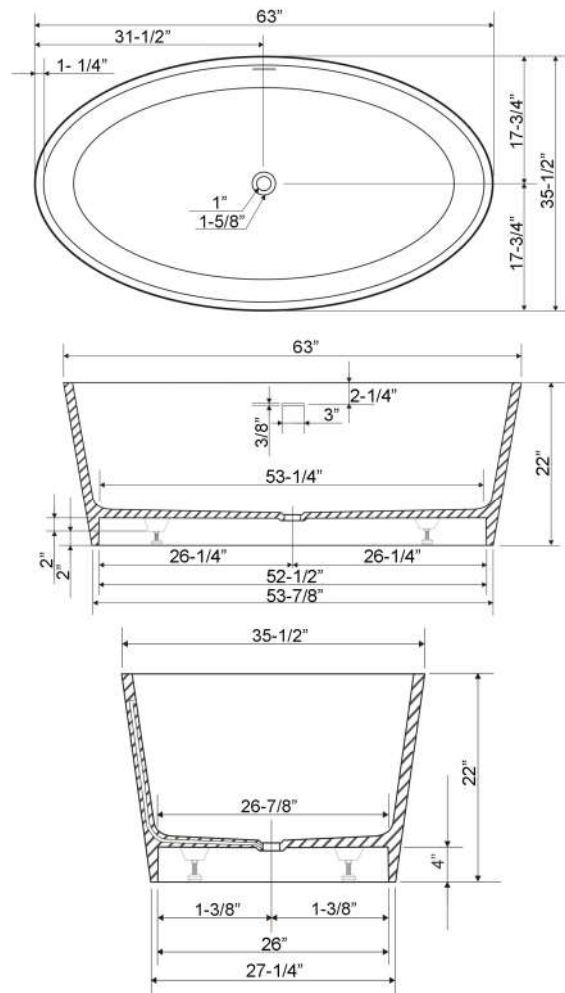

BATHTUB AIR JET KIT

Cat. No.
AIR KIT 1, AIR KIT 2

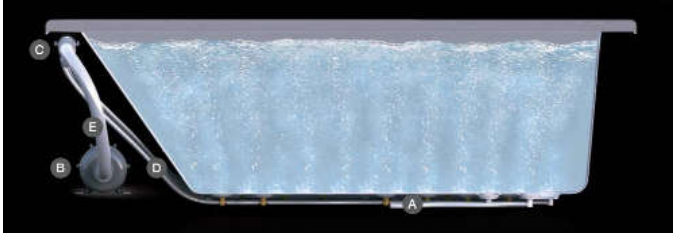

- A** AIR JET - Bottom air jets for maximum bubble action.
- B** BLOWER - The heart of the massage system.
- C** MANIFOLD - Double back flow security prevention device.
- D** FLEXIBLE PVC HOISING - IAPMO certified.
- E** MAIN AIR INTAKE HOSE - High temperature and pressure resistant.

Features:

- ▶ 750 Watt blower motor operates system
- ▶ 300 Watt air heater warms air
- ▶ System powered by 120V
- ▶ 16 brass air jets placed in bottom of tub
- ▶ Each air jet has 24 holes
- ▶ Air jet caps available in white (AIR KIT 1) or black (AIR KIT 2)
- ▶ Includes 1 1/4" x 3' main air hose plus 1 1/4" x 9' extension hose
- ▶ Automatic system purge after each use
- ▶ Automatic safety timer turns off system after 20 minutes
- ▶ Includes water tight remote control
- ▶ Compatible with most acrylic, copper and resin tubs with no feet
- ▶ Not available with cast iron tubs or tubs with feet

Air Kit is installed in tub before shipment

INSIDE TUB VIEW - WILL VARY BY TUB DESIGN



Air Jet



Remote

Oval bathtub
Sample jet configuration

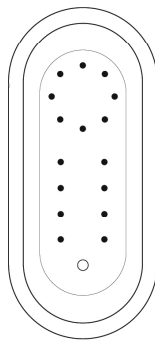

with end drain

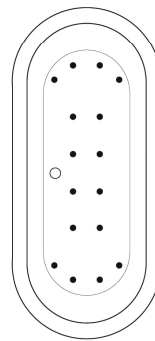

with center drain

Rectangular bathtub
Sample jet configuration

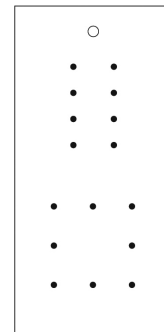

with end drain

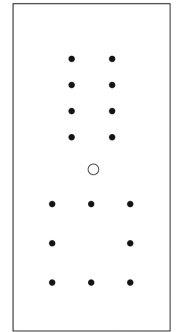

with center drain

Round bathtub
Sample jet configuration

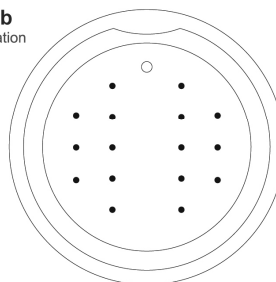

These diagrams are general representations.
Jet placement may vary dependent on tub shape

Features:

(16) Maxi Air Jets



Elbows for air jets



Tees for air jets