

## W Track System - Surface Mount

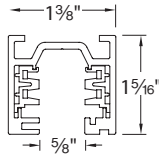

Fixture Type:

Catalog Number:

Project:

Location:

### PRODUCT DESCRIPTION

Heavy duty architectural grade track with two independently controllable circuits. Stem or cable suspensions available.

### FEATURES

- Power per Circuit: 1920W max (120V) , 4432W max (277V)
- Operating Current: Each circuit is rated 20A (2 x 20A = 40A max)
- Extruded aluminum construction
- UL & CUL listed
- 5 year WAC Lighting product warranty

### SPECIFICATIONS

**Materials:** Solid copper alloy bus bars in an extruded aluminum with a rectangular cross-sectional area of 4.2 mm<sup>2</sup>

**Electrical:** Electric feed capability through all jointers/feeders (except Power Connector and Flexible Connector) using standard 1/2 inch knock-outs

**Mounting:** Fixtures may be installed or removed anywhere along the track. Minimum fixture spacing is 1 foot. Track fixture has safety interlocks when installed/removed. Polarization is guaranteed throughout the system

**Finish:** Available in black powder coat (**BK**), white powder coat (**WT**), or platinum anodized (**PT**) finishes

**Standards:** UL & CUL listed

### ORDER NUMBER

Model	Length	Finish
<b>WT</b> 120V	<b>4</b> 4'	<b>BK</b> Black
<b>WHT</b> 277V	<b>8</b> 8'	<b>PT</b> Platinum
	<b>12</b> 12'	<b>WT</b> White

Each section includes two matching end caps.



Example: **WHT4-PT**











wacighting.com  
Phone (800) 526.2588  
Fax (800) 526.2585



Headquarters/Eastern Distribution Center  
44 Harbor Park Drive  
Port Washington, NY 11050









Central Distribution Center  
1600 Distribution Ct  
Lithia Springs, GA 30122







Western Distribution Center  
1750 Archibald Avenue  
Ontario, CA 91760

## W Track System - Surface Mount

Accessories	Model	Volt	Finish	Description
Live End Connector – Left Polarity 	<b>WEDL</b> <b>WHEDL</b>	120V 277V	<b>BK</b> <b>PT</b> <b>WT</b>	Direct wiring through ceiling. Polarity on left side of track.
Live End Connector – Right Polarity 	<b>WEDR</b> <b>WHEDR</b>	120V 277V		Direct wiring through ceiling. Polarity on right side of track.
"I" Connector 	<b>WPC</b> <b>WHPC</b>	120V 277V		Join two sections of track with electrical continuity.
"I" Power Connector 	<b>WIC</b> <b>WHIC</b>	120V 277V	<b>BK</b> <b>PT</b> <b>WT</b>	Power entry point at the connection of two tracks.
Flexible Connector 	<b>WFC</b> <b>WHFC</b>	120V 277V	<b>BK</b> <b>PT</b> <b>WT</b>	Transition from wall-to-wall, wall-to-ceiling, or ceiling-to-ceiling. Power feedable.
Canopy Plate 	<b>CP</b>	120V 277V	<b>BK</b> <b>PT</b> <b>WT</b>	Covers a standard 4" octagonal box.
"L" Connector Left Polarity 	<b>WLLC</b> <b>WHLLC</b>	120V 277V	<b>BK</b> <b>PT</b> <b>WT</b>	Join 2 track sections to make power feedable 90° left polarity turns.
"L" Connector Right Polarity 	<b>WRLC</b> <b>WHRLC</b>	120V 277V		Join 2 track sections to make power feedable 90° right polarity turns.
"T" Connector – Left 	<b>WLTC</b> <b>WHLTC</b>	120V 277V	<b>BK</b> <b>PT</b> <b>WT</b>	Join 3 track sections. Power feedable. Polarity on outside edge.
"T" Connector – Right 	<b>WRTC</b> <b>WHRTC</b>	120V 277V		Join 3 track sections. Power feedable. Polarity on inside edge.
"X" Connector 	<b>WXC</b> <b>WHXC</b>	120V 277V	<b>BK</b> <b>PT</b> <b>WT</b>	Join 4 track sections. Power feedable.

Track Current Limiter	Model	Volt	Rating	Finish	Description
Live end - Left 	<b>WEDL</b> <b>WHEDL</b>	120V 277V	<b>1A</b> 1 Amp <b>2A</b> 2.5Amp <b>5A</b> 5 Amp <b>7A</b> 7.5Amp <b>10A</b> 10Amp <b>12A</b> 12Amp	<b>BK</b> <b>PT</b> <b>WT</b>	Assures compliance to California Title 24 or ASHRAE 90.1 requirements
Live end - Right 	<b>WEDR</b> <b>WHEDR</b>	120V 277V			

Suspension	Model	Length	Finish	Description
Stem Kit With Power Feed 	<b>WMSP</b>	<b>6</b> 6" <b>12</b> 12" <b>24</b> 24" <b>36</b> 36" <b>48</b> 48" <b>96</b> 96"	<b>BK</b> <b>PT</b> <b>WT</b>	Power feed to connect with a Live End or any Joiner/Feeder. May be field cut.
Flexible Power Feed 	<b>WMFP</b>	<b>48</b> 48" <b>96</b> 96"		<b>BK</b> <b>PT</b> <b>WT</b>
Pendant Stem Kit 	<b>WMT-X</b>	<b>6</b> 6" <b>12</b> 12" <b>24</b> 24" <b>36</b> 36" <b>48</b> 48" <b>96</b> 96"	<b>BK</b> <b>PT</b> <b>WT</b>	Use to extend track from the ceiling. May be field cut.
T-Bar Stem Kit 		<b>WMT-TB</b>		Extend track from drop ceilings. May be field cut.
Sloped Ceiling Stem Kit 	<b>WMT</b>	<b>XS6</b> 6" <b>XS12</b> 12" <b>XS24</b> 24" <b>XS36</b> 36" <b>XS48</b> 48" <b>XS96</b> 96"	<b>BK</b> <b>PT</b> <b>WT</b>	Use to extend track from a sloped ceiling. May be field cut.
Sloped Ceiling Cable Kit 	<b>WMST</b>	<b>XS48</b> 48" <b>XS96</b> 96"	<b>BK</b> <b>PT</b> <b>WT</b>	Extend track from a sloped ceiling. May be field cut.
Suspension Cable Kit 	<b>WMST-X</b>	<b>48</b> 48" <b>96</b> 96"	<b>BK</b> <b>PT</b> <b>WT</b>	Extend track from the ceiling. May be field cut.
T-Bar Suspension Cable Kit 		<b>WMST-TB</b>		Extend track from drop ceilings. May be field cut.

Suspension Accessories	Model	Finish
Suspension Hanger Clip 	<b>WMT</b>	<b>BK</b> <b>PT</b> <b>WT</b>
"I" Power Connector Suspension Mount 	<b>WMPC</b>	<b>BK</b> <b>PT</b> <b>WT</b>
Live End Suspension Mount 	<b>WMED</b>	<b>BK</b> <b>PT</b> <b>WT</b>
Power Feed Coupler Suspension Mount Use with "I" Power Connector 	<b>WMIC</b>	<b>BK</b> <b>PT</b> <b>WT</b>
"L" Connector Suspension Mount 	<b>WMLC</b>	<b>BK</b> <b>PT</b> <b>WT</b>
"T" Connector Suspension Mount 	<b>WMTC</b>	<b>BK</b> <b>PT</b> <b>WT</b>
"X" Connector Suspension Mount 	<b>WMXC</b>	<b>BK</b> <b>PT</b> <b>WT</b>

wacighting.com  
Phone (800) 526.2588  
Fax (800) 526.2585

Headquarters/Eastern Distribution Center  
44 Harbor Park Drive  
Port Washington, NY 11050

Central Distribution Center  
1600 Distribution Ct  
Lithia Springs, GA 30122

Western Distribution Center  
1750 Archibald Avenue  
Ontario, CA 91760

## Straight Configuration

- A WEDR** Live end connector (right)
- B WIC** I power connector
- C WPC** I connector
- D WEC** End cap

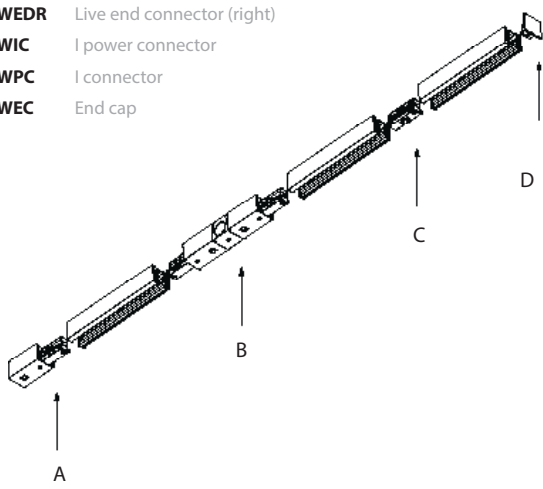

## Flexible Configurations

- A WEDR** Live end connector (right)
- B WEDL** Live end connector (left)
- C WFC** Flexible connector
- D WEC** End cap

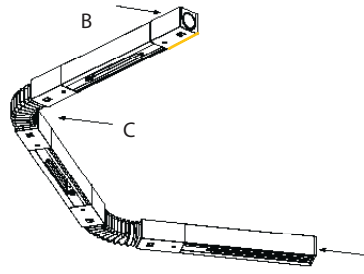

Horizontal Ceiling Mount

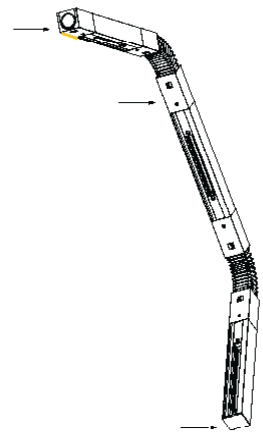

Vertical Wall-to-Ceiling Mount

## Grid Configuration

- A WLLC** L Connector Left
- B WLTC** T Connector Left
- C WRTC** T Connector Right
- D WXC** X Connector

= Indicates Electrical Continuity

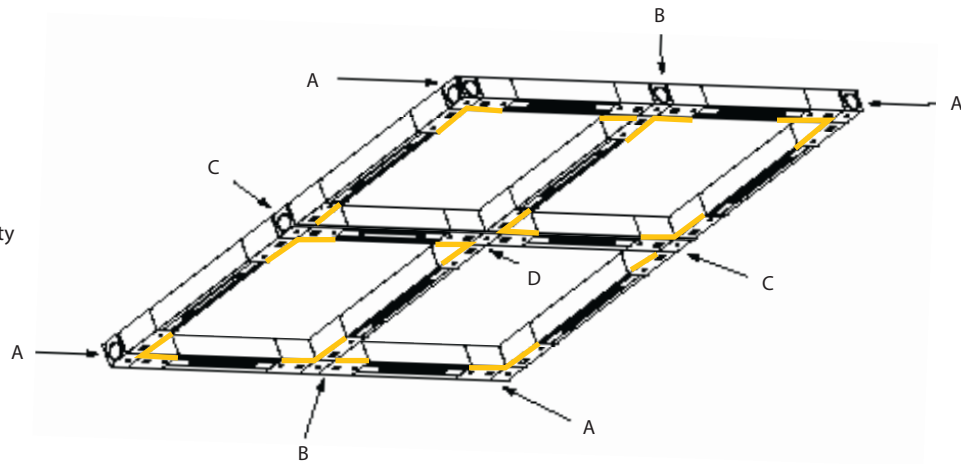

## Cable Suspension Mount

- A WMFP** Flexible Stem kit with power feed
- B WMED** Live end suspension mount
- C WEDL** Live end connector (left)
- D WMST-X** Cable suspension kit
- E WMT** Suspension hanger clip
- F WMST-TB** T bar cable suspension kit
- G WMST-XS** Sloped ceiling cable kit
- H WMLC** L connector suspension mount
- I WLLC** L connector left
- J WEC** End cap

Use one support for every 4 feet

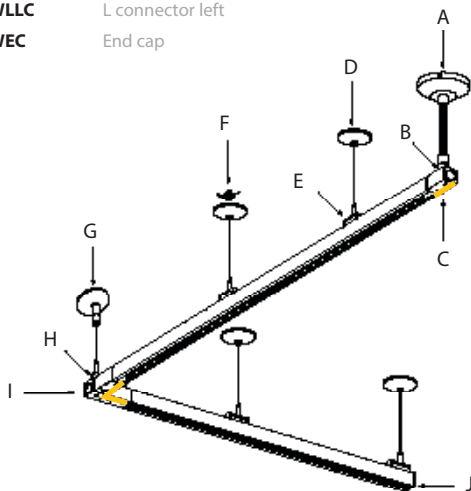

## Stem Suspension Mount

- A WMSP** Stem kit with power feed
- B WMED** Live end suspension mount
- C WEDR** Live end connector (right)
- D WMT-XS** Sloped ceiling stem kit
- E WMT** Suspension hanger clip
- F WMT-TB** T bar stem kit
- G WMT-X** Stem kit
- H WMLC** L connector suspension mount
- I WLLC** L connector left
- J WEC** End cap

