

SAFETY INFORMATION

Released Date: 2020-12-02

Please read and understand this entire manual before attempting to assemble, install or operate the product.

WARNING

- RISK OF ELECTRIC SHOCK - Before beginning installation, turn off electricity at the circuit breaker box or the main fuse box.
- RISK OF FIRE - Use bulbs specified by the markings and/or labels on the fixture.

CAUTION

- For your safety, read instructions completely before beginning installation.
- If in doubt about electrical installation, consult a licensed electrician.
- Turn off electricity to fixture before replacing the bulb(s).

TOOLS REQUIRED

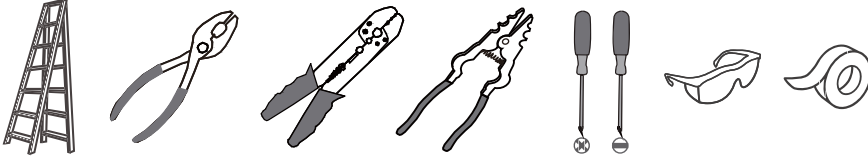

CARE AND MAINTENANCE

- Wipe clean using soft, dry cloth or static duster. Always avoid using harsh chemicals and abrasives to clean fixture as they may damage the finish.

If you need further assistance call Quozel Customer Care at 1-800-645-3184 (9:00am – 5:00pm EST), or visit us on-line at www.quozel.com.

PACKAGE CONTENTS

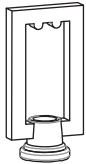

A Fixture Loop
x 1

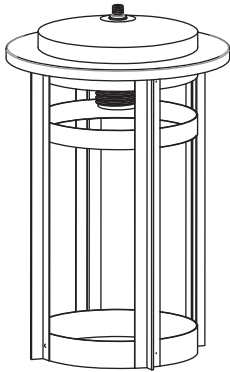

B Fixture Body
x 1

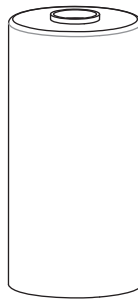

C Glass Shade
x 1



D Socket Collar
[pre-assembled to Fixrure Body]
x 1

MOUNTING HARDWARE

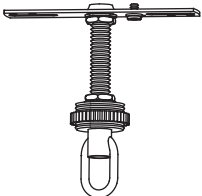

AA Crossbar Assembly
x 1



BB Wire Connector
x 3



CC Outlet Box Screw
x 2

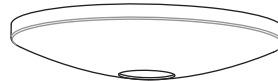

DD Ceiling Canopy
x 1

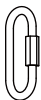

EE Quick Link
x 2



FF Fixture Chain
x 1

INSTALLATION

1 Install Fixture Loop

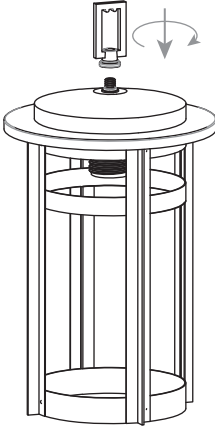

A diagram showing a cylindrical fixture housing with a loop being attached to its top. A curved arrow indicates the rotation of the loop.

2 Install Crossbar Assembly

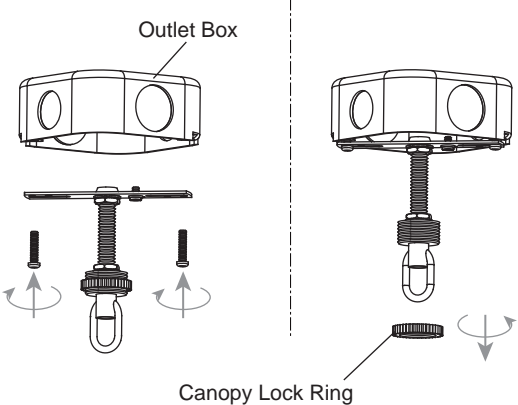

Outlet Box

Canopy Lock Ring

A diagram showing an outlet box with two circular openings. Below it, a crossbar assembly with a central screw and a hook is shown. To the right, the crossbar is being inserted into the outlet box. Below that, a canopy lock ring is shown being attached to the bottom of the crossbar assembly.

3 Install Fixture Chain

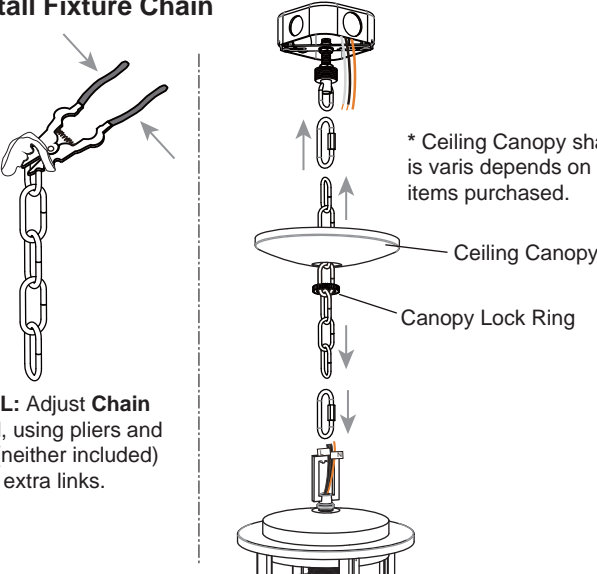

* Ceiling Canopy shape is varies depends on items purchased.

Ceiling Canopy

Canopy Lock Ring

OPTIONAL: Adjust Chain as desired, using pliers and soft cloth (neither included) to remove extra links.

A diagram showing a chain being attached to a ceiling canopy and a canopy lock ring. The ceiling canopy is shown as a shallow dish. The canopy lock ring is a small ring. The chain is being pulled down to connect to a fixture housing. A note indicates that the ceiling canopy shape varies by item. An optional note suggests adjusting the chain length with pliers and a soft cloth.

4 Pull Supply Wires

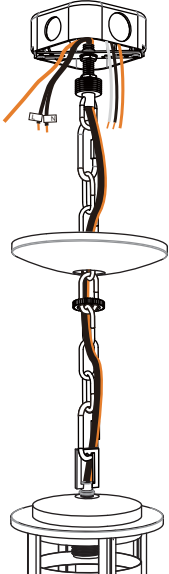

Pull the supply wires with ground wire through the chain alternate links.

A diagram showing the supply wires (white, black, and ground) being pulled through the chain links. The wires are shown entering the fixture housing from the ceiling canopy.

5 Wiring

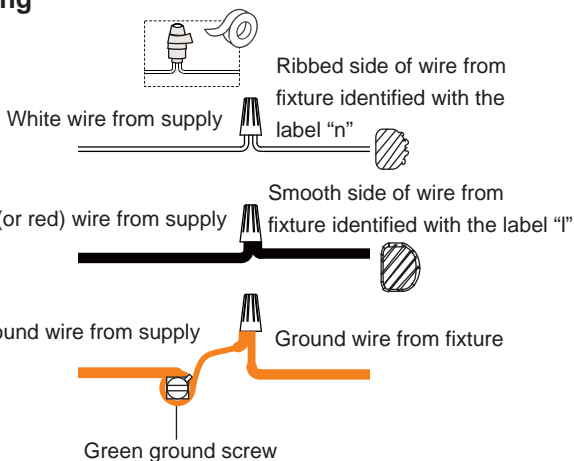

Ribbed side of wire from fixture identified with the label "n"

White wire from supply

Smooth side of wire from fixture identified with the label "l"

Black (or red) wire from supply

Ground wire from supply

Ground wire from fixture

Green ground screw

A diagram showing the wiring connections. It shows a white wire from the supply connected to the ribbed side of the fixture wire (labeled 'n'). A black or red wire from the supply is connected to the smooth side of the fixture wire (labeled 'l'). A ground wire from the supply is connected to a green ground screw on the fixture, which is also connected to a ground wire from the fixture.

6 Install Ceiling Canopy

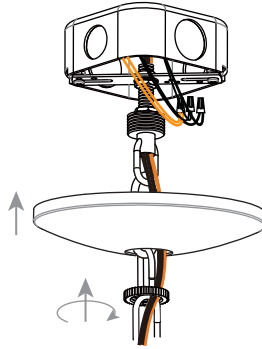

* Ceiling Canopy shape is varies depends on items purchased.

A diagram showing a ceiling canopy being attached to the fixture housing. The canopy is shown as a shallow dish. A note indicates that the ceiling canopy shape varies by item.

INSTALLATION

7

Install Glass Shade

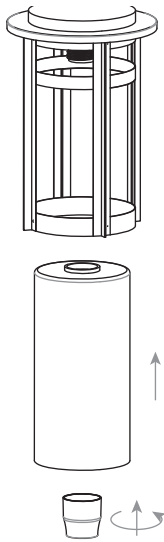

8

Install Bulb

Install the correct bulb referring to fixture markings and/or labels for maximum wattage.

Recommended Bulb type (not included):

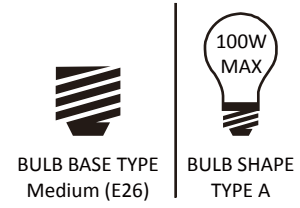

Your installation is now complete! Restore electricity and save this sheet for future reference.