

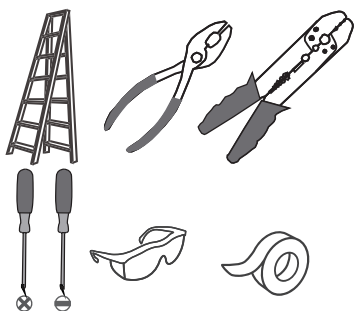



# Installation Guide For Style MVL642IN

## Tools Required



## Light Source

 <b>5W MAX</b> <b>LED RU 10 BULB</b>	 <b>BULB BASE TYPE Medium (E26)</b>	 <b>100W MAX</b> <b>BULB SHAPE TYPE A</b>
<b>2 BULBS REQUIRED BULBS INCLUDED</b>	<b>6 BULBS REQUIRED BULBS NOT INCLUDED</b>	

## Fixture Height Adjustable 22" to 46"

### Warnings and Cautions

Turn off the electricity at the circuit breaker before installation. Consult a licensed electrician if in doubt about installation.

Turn off power to the fixture and allow the bulbs to cool before replacing.

## Package Contents



**Preparation:** Identify and inspect all parts before beginning the installation.

Missing or damaged parts? Contact your original place of purchase.

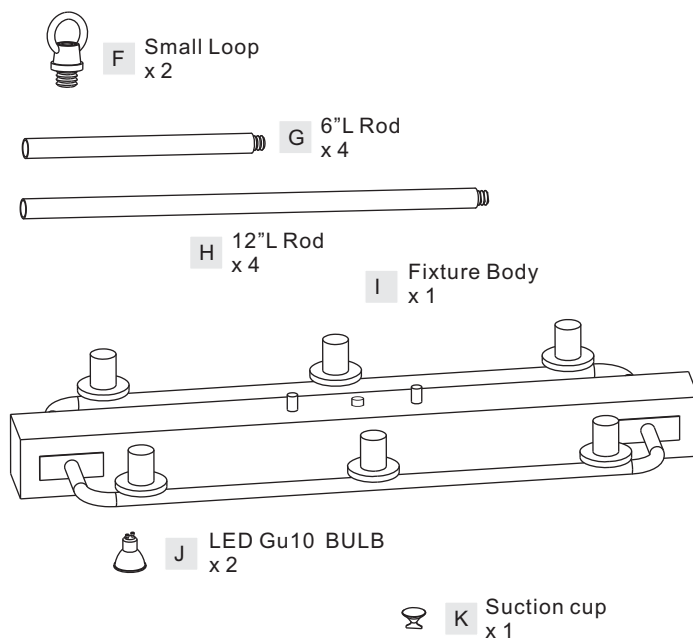
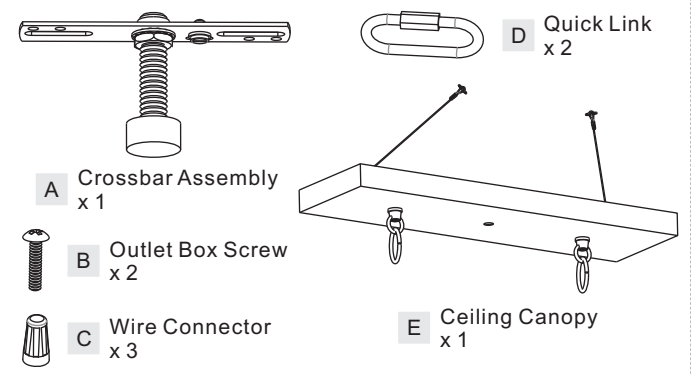
### PARTS BAG

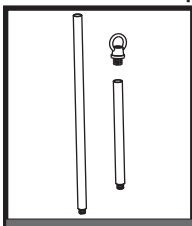
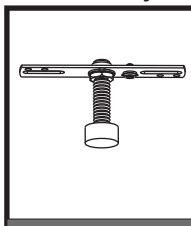
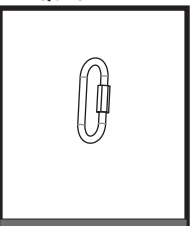
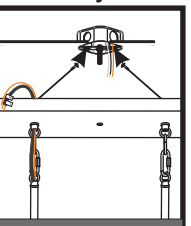
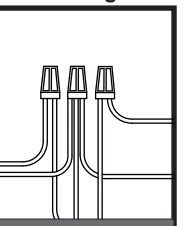
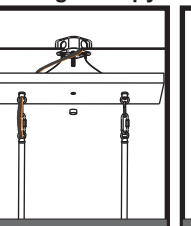

## Table of Contents

Rods & Small Loop	Crossbar Assembly	Quick Link	Lanyard	Wiring	Ceiling Canopy	Bulb
						
<b>STEP 1</b>	<b>STEP 2</b>	<b>STEP 3</b>	<b>STEP 4</b>	<b>STEP 5</b>	<b>STEP 6</b>	<b>STEP 7</b>

# STEP 1

**Optional Rods**

**8' ceiling:**  
(4) 6"L + (2) 12"L rods

**9' ceiling:**  
(4) 6"L + (4) 12"L rods

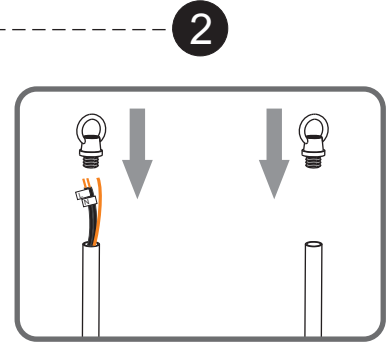
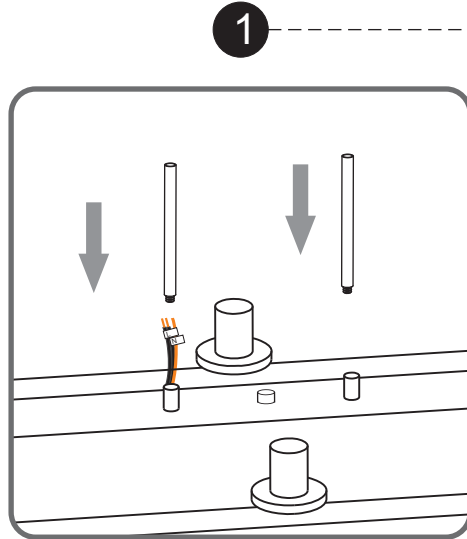
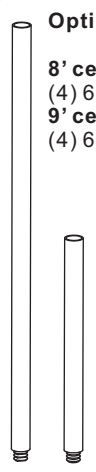

# STEP 2

1

**Step 1**  
**Install crossbar assembly**



2

**Step 2 - 3**  
**Test fitting ceiling canopy to nipple**

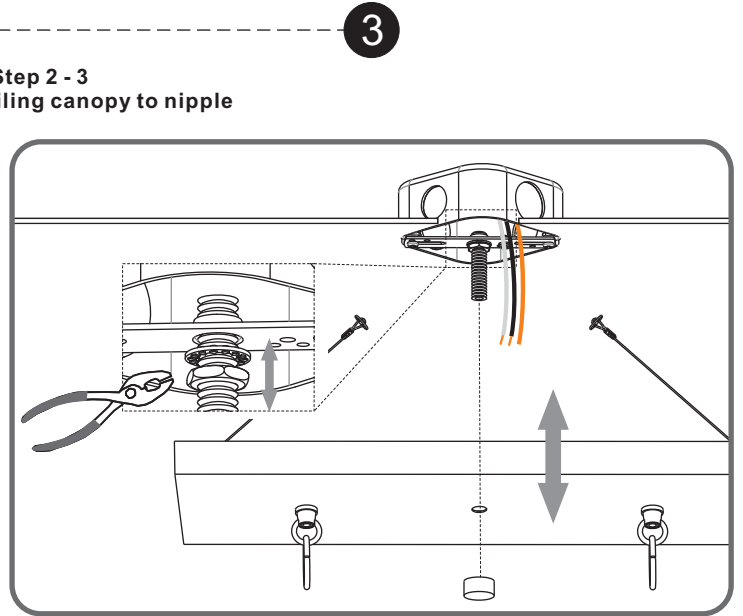
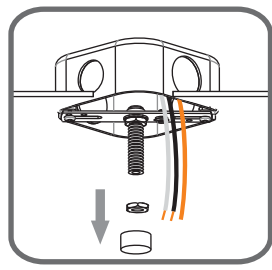

# STEP 3

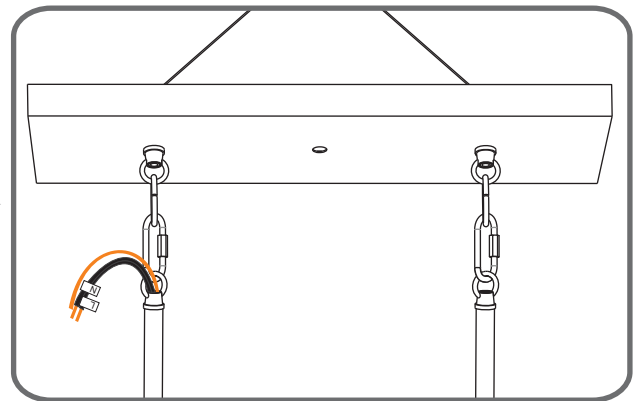
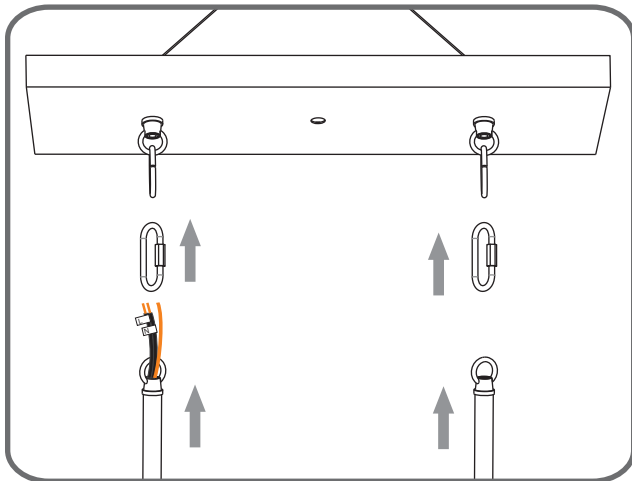

# STEP 4

1

Step 1  
Feed the fixture wires  
through the ceiling canopy

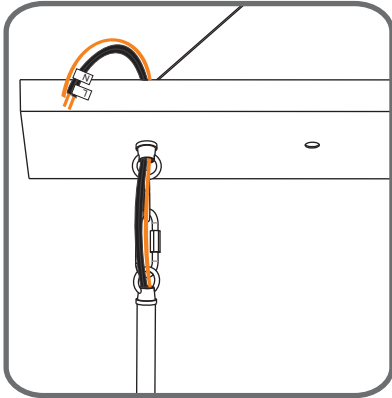

2

Step 2  
Install Lanyard

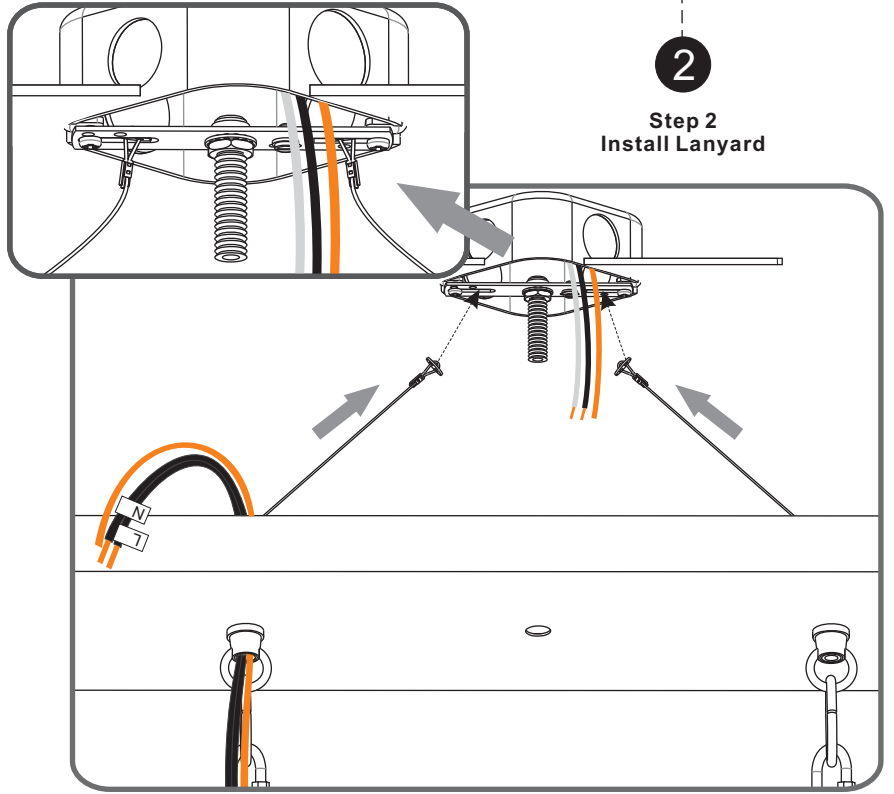

# STEP 5

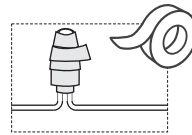

White wire (neutral)  
from outlet box

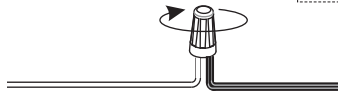

Supply wire from fixture  
Ribbed side or identified  
with the Label "N"

Black or Red wire (hot)  
from outlet box

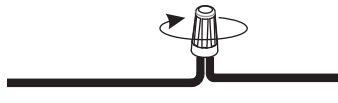

supply wire from fixture  
Smooth side or identified  
with the label "L"

Bare or Green ground wire  
from outlet box

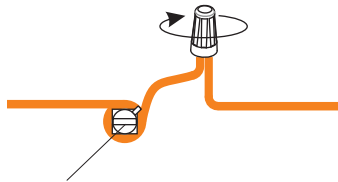

Ground wire  
from Fixture

\*Green Ground Screw  
on crossbar optional

**STEP 6**

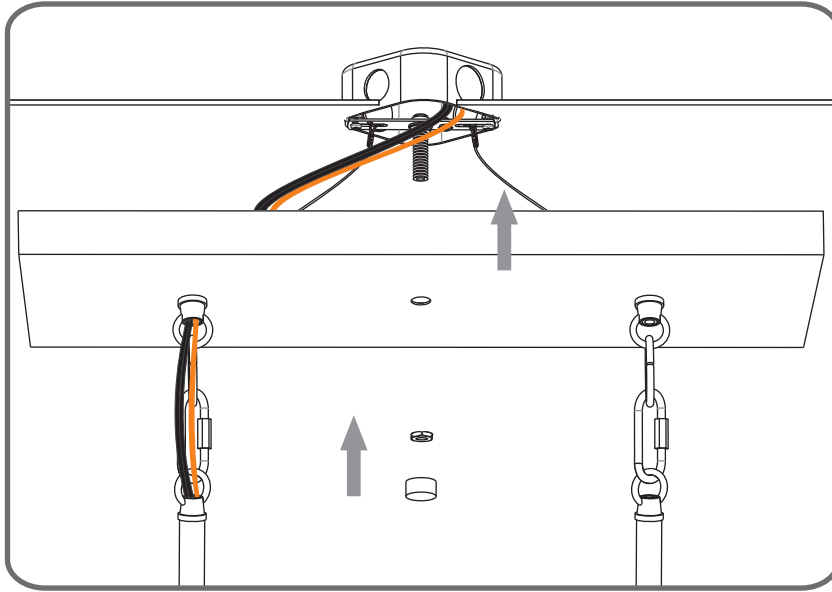

**STEP 7**

