

**Tools Required**

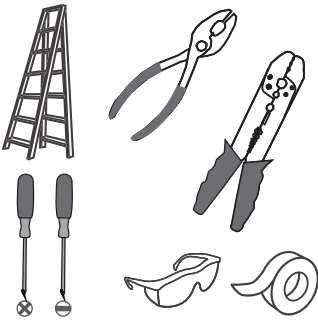

**Light Source**



LED G9 4.5W Bulb

**1 BULBS REQUIRED INCLUDED**

**Warnings and Cautions**

Turn off the electricity at the circuit breaker before installation. Consult a licensed electrician if in doubt about installation.

Turn off power to the fixture and allow the bulbs to cool before replacing.

**Package Contents**

**Preparation:** Identify and inspect all parts before beginning the installation.

Missing or damaged parts? Contact your original place of purchase.

**PARTS BAG**

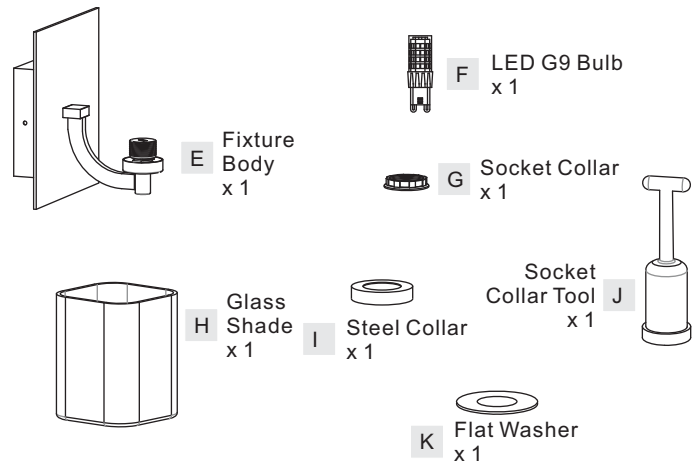

**Table of Contents**

Inner Backplate	Wiring	Fixture Body	Shade & Bulb
<b>STEP 1</b>	<b>STEP 2</b>	<b>STEP 3</b>	<b>STEP 4</b>

### STEP 1

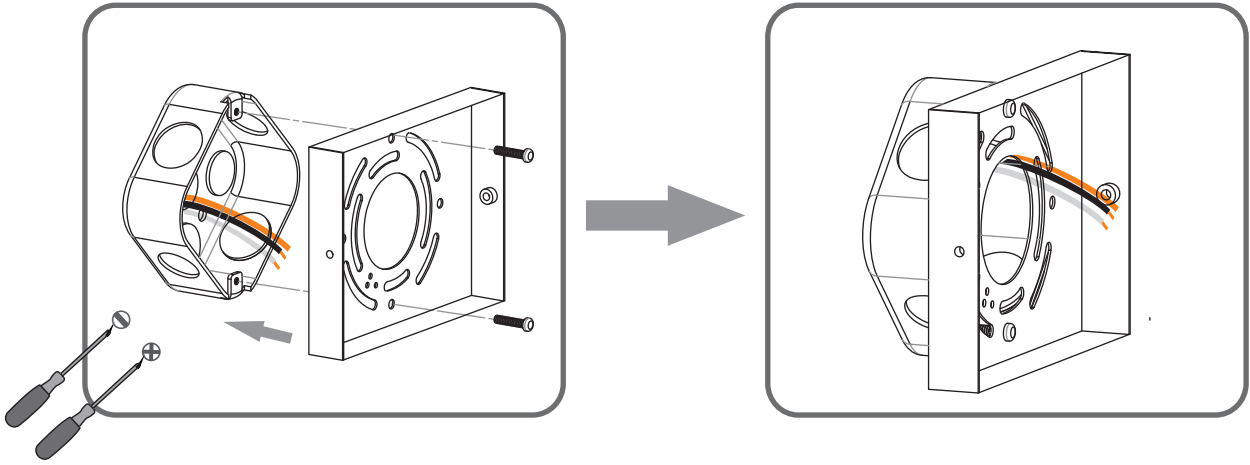

### STEP 2

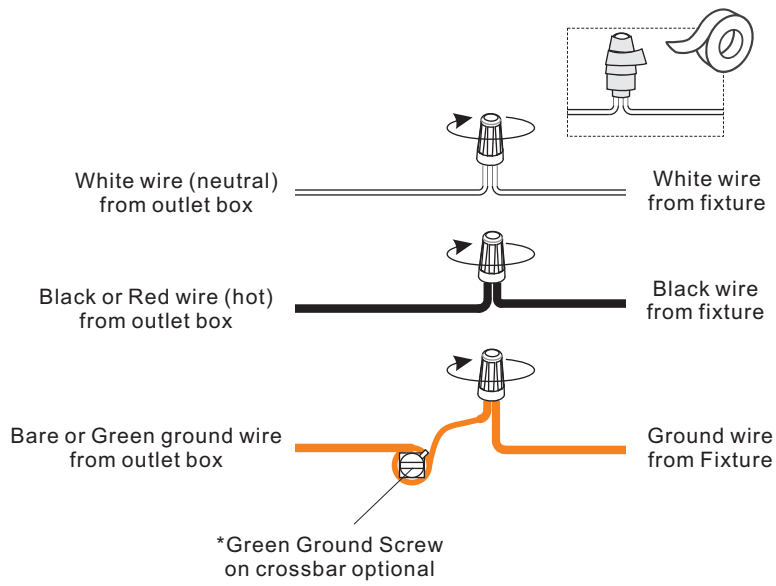

### STEP 3

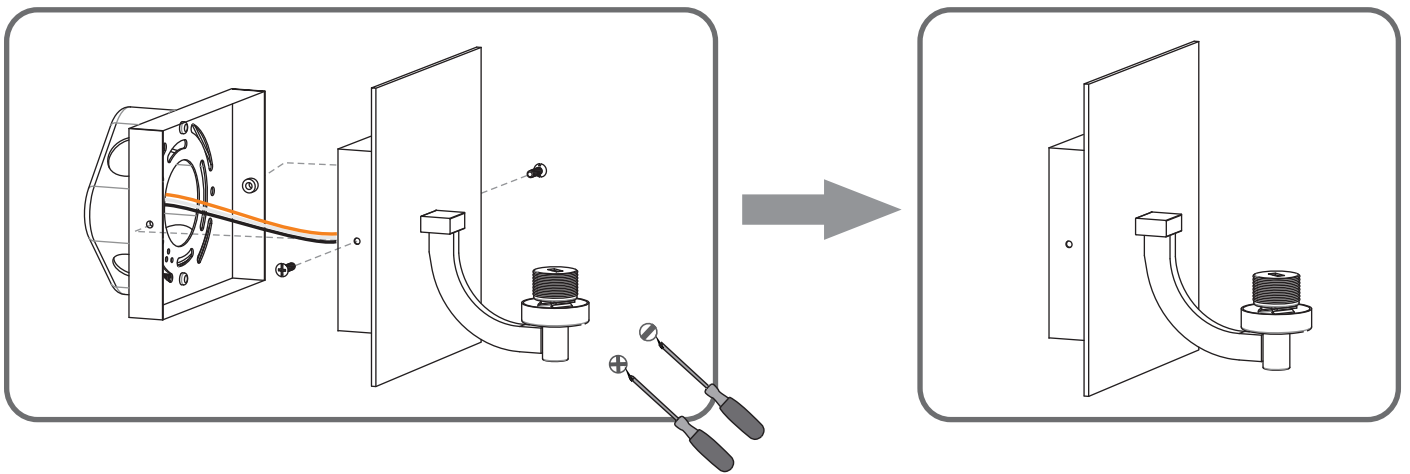

**STEP 4**

