

Please go to www.quoizel.com for product cleaning tips. Go to the **Care + Maintenance** selection.

Tools Required: Flathead screwdriver, Phillips screwdriver, pliers, wire cutters, wire strippers, electrical tape, safety glasses.

Light Source: (4) A19 Medium Base bulbs 100W Maximum, Medium Base Vintage Bulbs are recommended, bulbs not included.

Estimated Assembly Time: 20-30 minutes

Preparation: Identify and inspect all parts before beginning installation. Check package content list and diagrams below to ensure all parts are present. If any parts are missing or damaged, do not attempt to assemble, install, or operate the fixture. Contact customer service for replacement parts.

Fixture can only be mounted in the direction indicated on page 2.

⚠ Warnings and Cautions

Turn off electricity at circuit breaker or main fuse box before installation. Consult a licensed electrician if in doubt.

These instructions are provided for your safety. It is very important you read them completely before installing the fixture. We strongly recommend that a licensed, professional electrician perform the installation.

Disconnect fixture from power source before replacing bulbs. Make sure bulbs are given sufficient time to cool before removal.

Package Contents

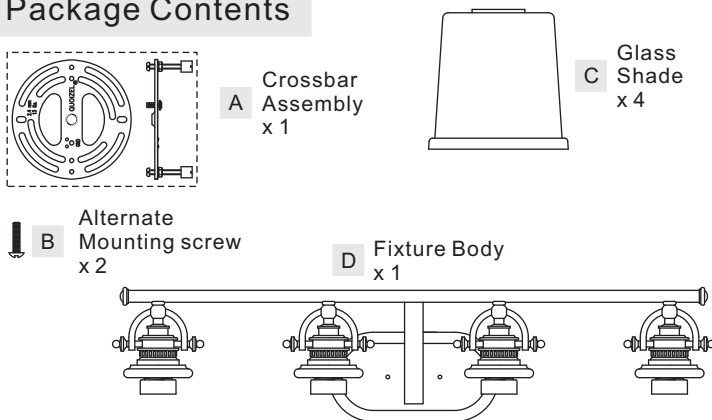

screwing the mounting screws or alternate short mounting screws in or out of the crossbar until the correct length is achieved. Once the backplate and Fixture Body (D) is secure, remove the mounting ball and Fixture Body (D) and proceed to Step 3.

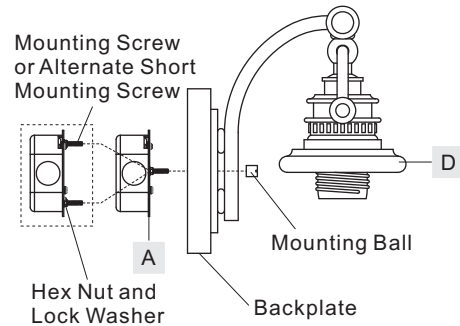

Figure 2

STEP 1 - Installing the Crossbar Assembly

A. Pass the supply wires through the Crossbar Assembly (A). Attach the Crossbar Assembly (A) to the Outlet Box with the head of the Green Ground Screw facing you. Secure the Crossbar Assembly (A) with Outlet Box Screws (not included). Tighten until snug. Note: Use the Alternate Shorter Mounting Screw (B) if your installation requires a shorter mounting screw.

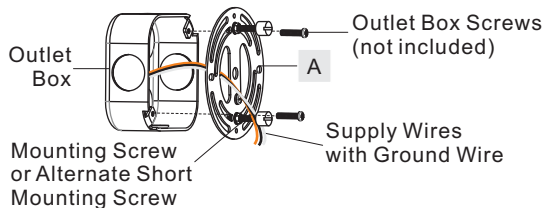

Figure 1

STEP 2 - Test Fit the Backplate to the Crossbar Assembly

A. Remove the mounting balls from the Crossbar Assembly (A). Place the backplate and Fixture Body (D) onto the Crossbar Assembly (A) and secure with mounting balls. Note: The backplate and Fixture Body (D) should be snug against the wall and held tight with the mounting balls. If it is not, adjust the length of the mounting screw or alternate short mounting screw on the Crossbar Assembly (A) by unscrewing the preassembled hex nut and lock washer and then

STEP 3 - Wire Connections

A. Wrap bare or green ground wire around green ground screw on the crossbar, no less than 2 inches from the end of the wire. Tighten the green ground screw.

B. Use standard wire connectors (not included) to make all wire connections. Twist connectors until wires are tightly joined together. Wrap each connection with approved electrical tape and carefully stuff all the connected wires into the Outlet Box.

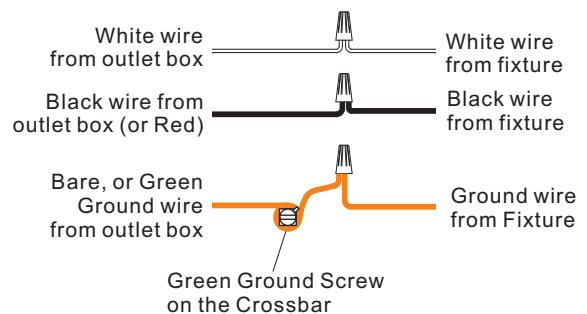

Figure 3

Thank you for purchasing a Quoizel product.
Need assistance with parts or assembly? Call Quoizel customer service at 1-800-645-3184
or visit us on-line at www.quoizel.com

STEP 4 - Install the Fixture Body

A. Position the backplate and Fixture Body (D) onto the Crossbar Assembly (A). Place the holes in the backplate over the mounting screws or alternate short mounting screws. Secure the Fixture Body (D) by using the mounting balls and hand tighten the mounting balls until snug.

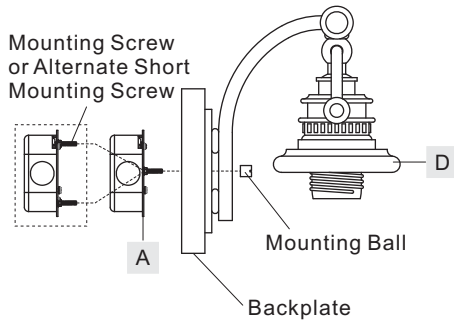

Figure 4

STEP 5 - Install Glass Shades and Bulbs

A. Remove socket collars from sockets.
 B. Place Shades (C) over sockets and secure with previously removed socket collars. Hand tighten until snug.
 C. Insert bulbs onto sockets and screw snugly into place.

Your fixture is now assembled and ready to use. Enjoy!

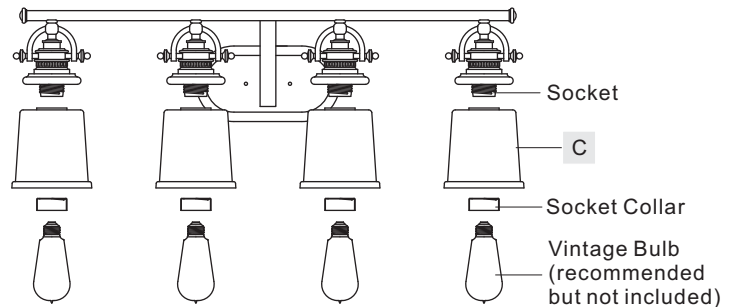
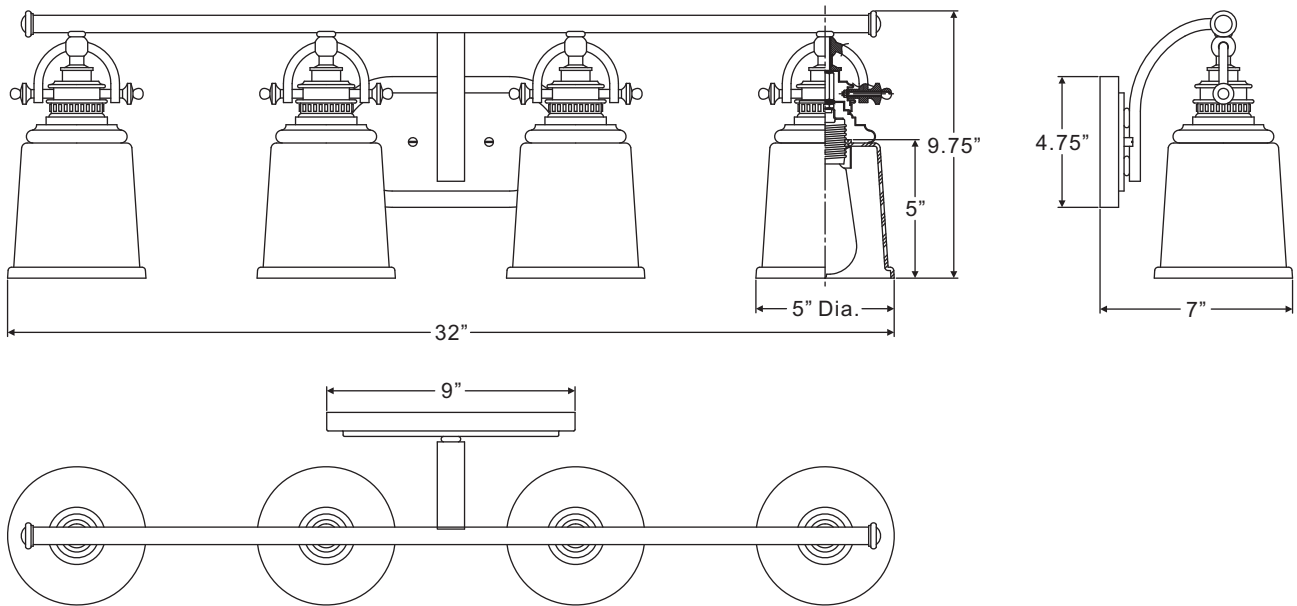
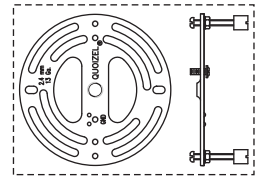

Figure 5

GRT8604C

FINISH: POLISHED CHROME

NOTE: ALL DIMENSIONS ARE ROUNDED UP TO THE NEAREST 1/4"



Thank you for purchasing a Quoizel product.
 Need assistance with parts or assembly? Call Quoizel customer service at 1-800-645-3184
 or visit us on-line at www.quoise.com