

Please go to www.quoizel.com for product cleaning tips. Go to the **Care + Maintenance** selection.

Tools Required: Flathead screwdriver, Phillips screwdriver, pliers, wire cutters, wire strippers, electrical tape, safety glasses.

Light Source: (4) A19 Medium Base Bulbs 60W Maximum, Medium Base Vintage Bulbs are recommended, bulbs not included.

Estimated Assembly Time: 30-45 minutes

Preparation: Identify and inspect all parts before beginning installation. Check package content list and diagrams below to be sure all parts are present. If any parts are missing or damaged, do not attempt to assemble, install, or operate the fixture. Contact customer service for replacement parts.

⚠ Warnings and Cautions

Turn off electricity at circuit breaker or main fuse box before installation. Consult a licensed electrician if in doubt.

These instructions are provided for your safety. It is very important you read them completely before installing the fixture. We strongly recommend that a licensed, professional electrician perform the installation.

Disconnect fixture from power source before replacing bulbs. Make sure bulbs are given sufficient time to cool before removal.

Package Contents

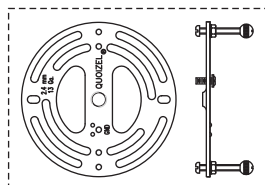

A Crossbar Assembly x 1

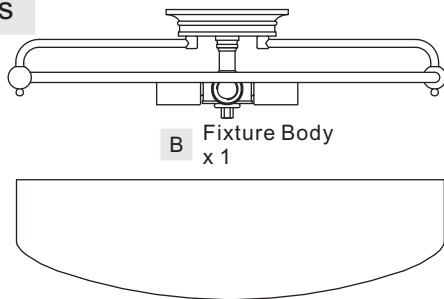

B Fixture Body x 1

- C** Nipple with Hex Nut x 1
- D** Spacer Tube x 1
- E** Check Ring x 1
- F** Big Flat Washer x 1
- G** Big Rubber Washer x 1

- H** Shade x 1
- I** Small Rubber Washer x 1
- J** Small Flat Washer x 1
- K** Hex Nut x 1
- L** Cap x 1
- M** Finial x 1

STEP 2 – Test Fitting Ceiling Canopy to Crossbar Assembly

A. Remove mounting balls from the Crossbar Assembly (A). Fit the ceiling canopy and Fixture Body (B) to the Crossbar Assembly (A) and secure with mounting balls. Note: The ceiling canopy should be snug against the ceiling and the mounting balls. If not, adjust the length of the nipple on the Crossbar Assembly (A) by unscrewing the preassembled hex nut and lock washer and then screwing the mounting screws in or out of the crossbar until the correct length is achieved. Once the ceiling canopy and Fixture Body (B) is secure, remove the mounting ball and ceiling canopy and Fixture Body (B) and proceed to Step 3.

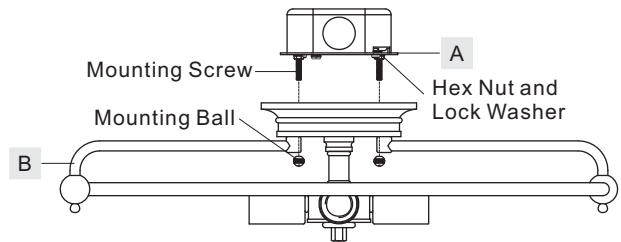

Figure 2

STEP 1 – Installing the Crossbar Assembly

A. Pass the supply wires from outlet box through the Crossbar Assembly (A). Attach the Crossbar Assembly (A) to the outlet box with the head of the green ground screw facing you. Secure the Crossbar Assembly (A) with outlet box screws (not included). Tighten until snug.

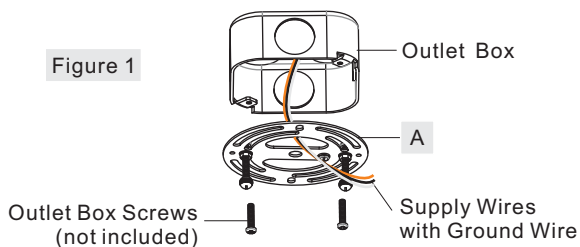

Figure 1

STEP 3 - Wire Connections

A. Wrap bare or green ground wire around green ground screw on the crossbar, no less than 2 inches from the end of the wire. Tighten the green ground screw.
B. Use standard wire connectors (not included) to make all wire connections. Twist connectors until wires are tightly joined together. Wrap each connection with approved electrical tape and carefully stuff all the connected wires into the Outlet Box.

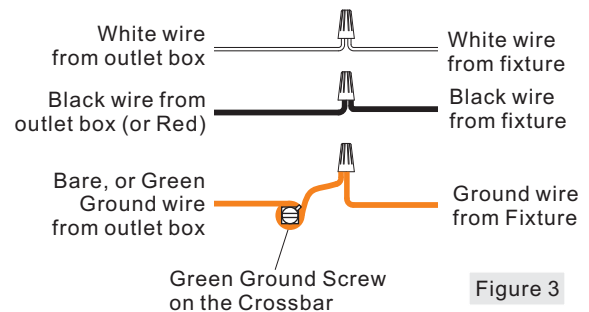

Figure 3

Thank you for purchasing a Quoizel product.
Need assistance with parts or assembly? Call Quoizel customer service at 1-800-645-3184
or visit us on-line at www.quoizel.com

STEP 4 - Install the Fixture

A. Carefully tuck all wires into the outlet box and position the ceiling canopy and Fixture Body (B) over the outlet box. Align the holes in the ceiling canopy with the mounting screws, then attach the ceiling canopy and Fixture Body (B) using the previously removed mounting balls. Hand tighten until snug.

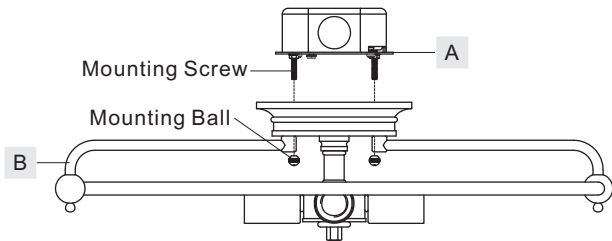

Figure 4

STEP 5 - Install Shade and Cap

- Thread the hex nut end of the Nipple with Hex Nut (C) into the hex coupling on the bottom center of the Fixture Body (B). By using pliers, thread the hex nut against the hex coupling and hand tighten until snug.
- Insert bulbs onto sockets and screw snugly into place.
- Place Spacer Tube (D), Check Ring (E), Big Flat Washer (F), Big Rubber Washer (G), Shade (H), Small Rubber Washer (I) and Small Flat Washer (J) over the end of the Nipple (C) as shown. Secure them together with the Hex Nut (K). Hand tighten until snug.
- Place the Cap (L) over the end of the Nipple (C) and secure with the Finial (M). Hand tighten until snug.

Your fixture is now assembled and ready to use. Enjoy!

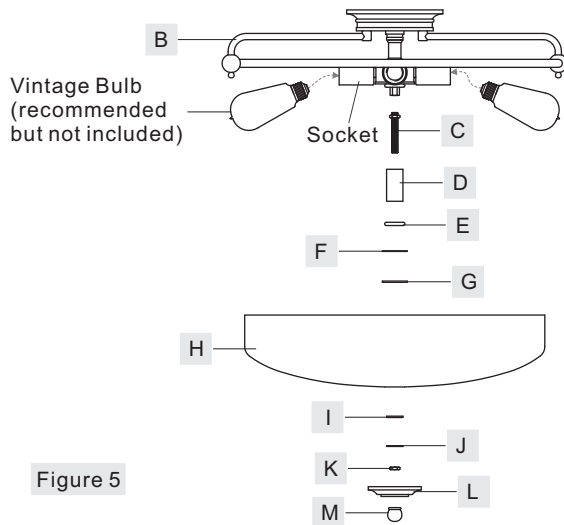
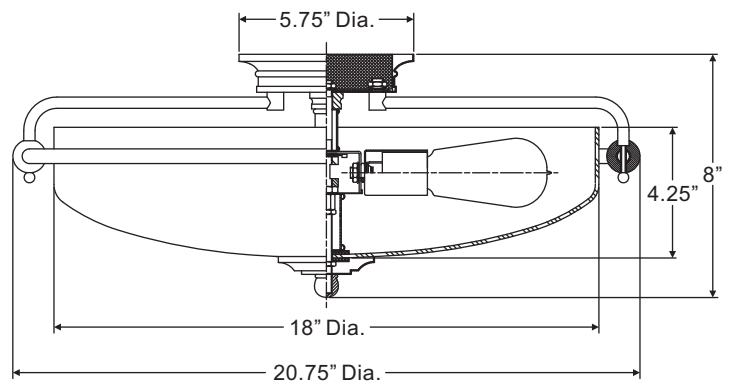
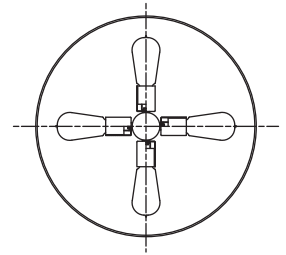
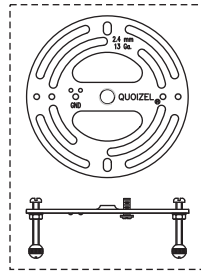

Figure 5

GFC1621PN

FINISH: PALLADIAN BRONZE



NOTE: ALL DIMENSIONS ARE ROUNDED UP TO THE NEAREST 1/4"

Thank you for purchasing a Quozel product.
Need assistance with parts or assembly? Call Quozel customer service at 1-800-645-3184
or visit us on-line at www.quezel.com