

PRODUCT NAME: Cluster 8-Light Chandelier
ITEM NUMBER: 38504

Please consult your electrician for Hang fixture and wiring.

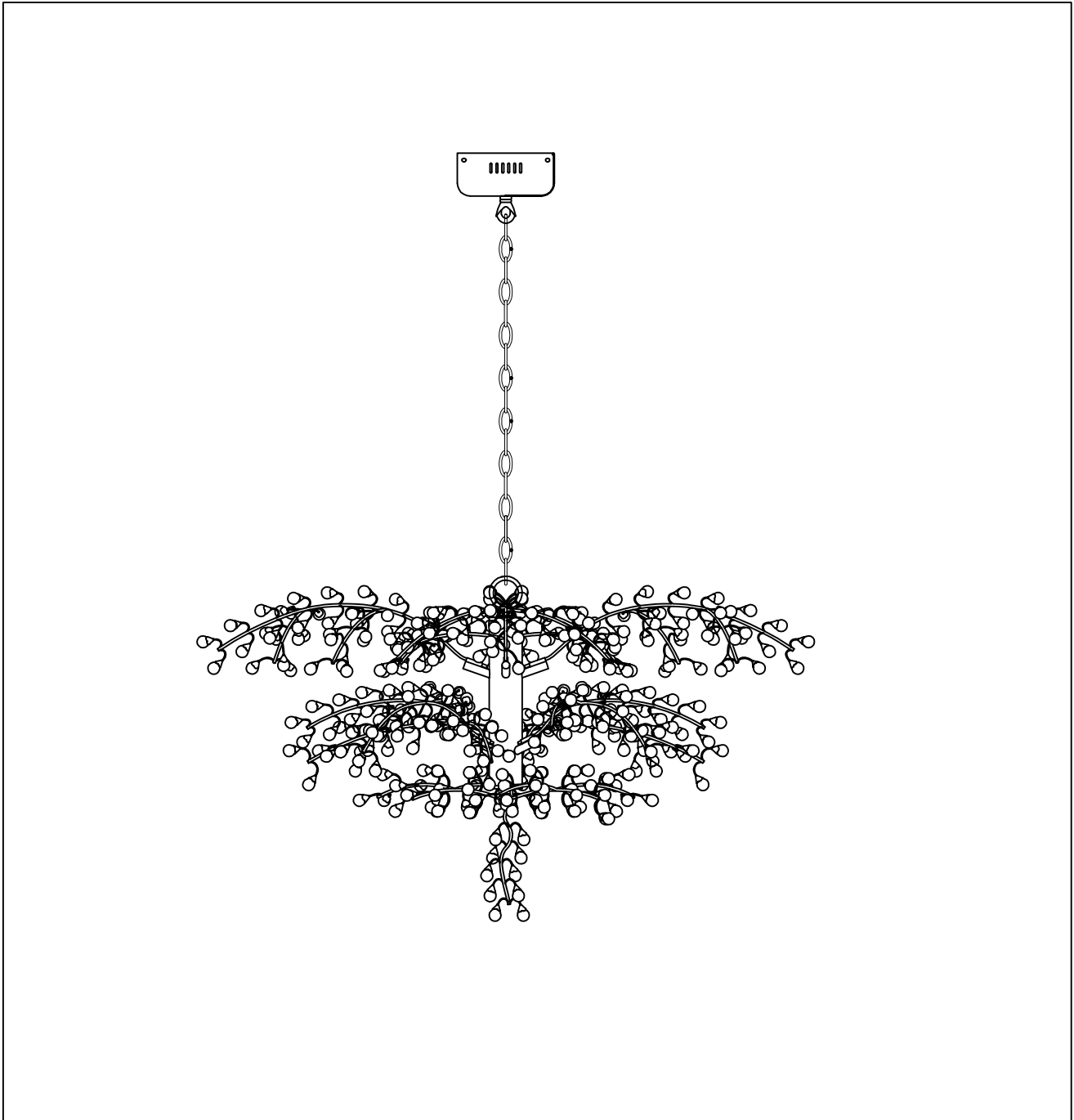

Bulb (included) : 8*G4 1.2W

IMPORTANT: Turn off power at the main fuse or circuit breaker box before starting installation

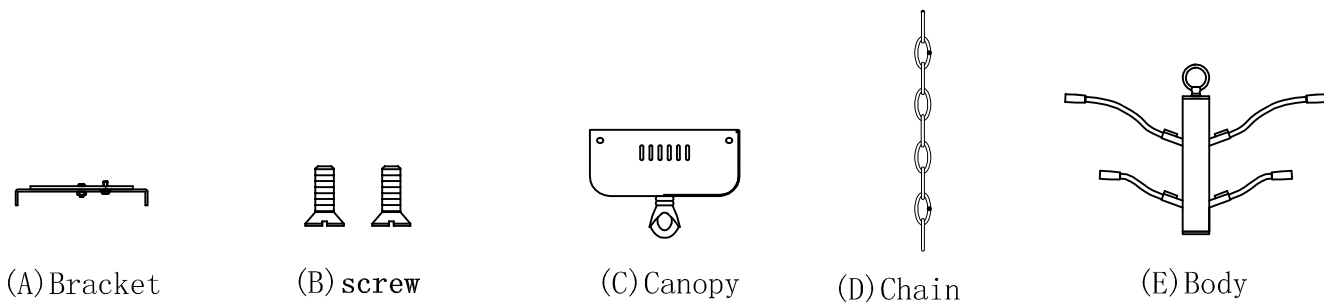

Locate all hardware & components before discarding packaging

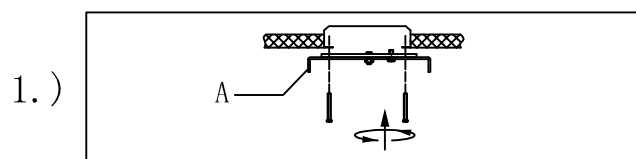
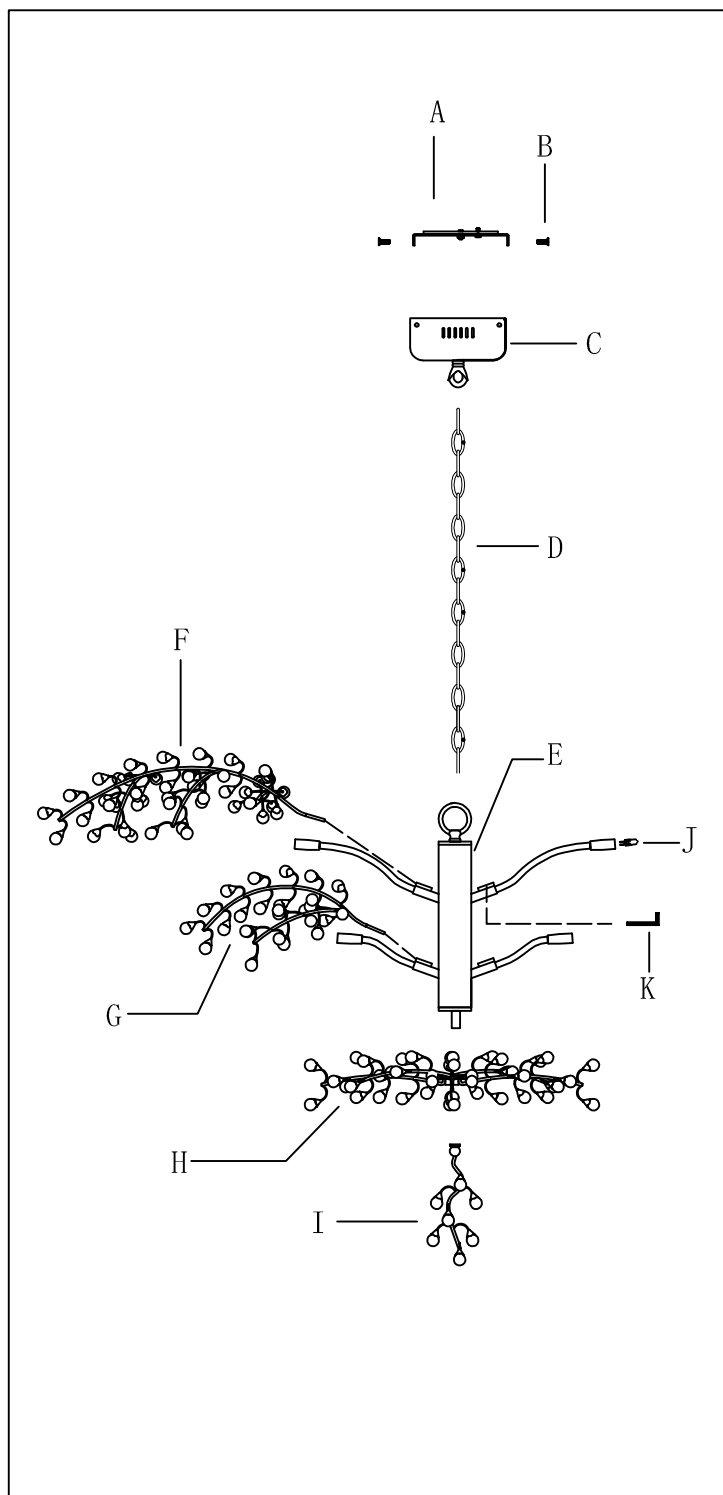

Step. 1: Remove mounting bracket (A) from fixture and install to electrical box.

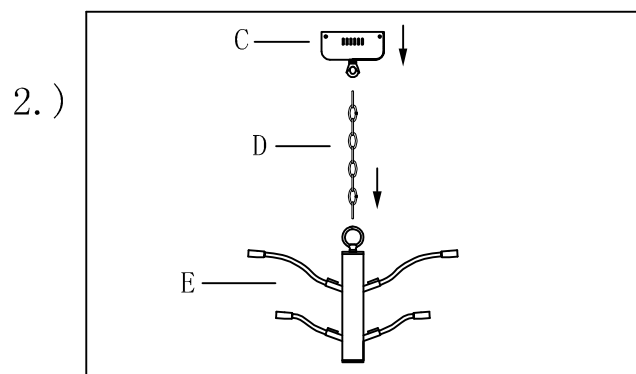

Step. 2: Run wire through stems and chain (C) and combine chain lengths to meet desired mounting height.

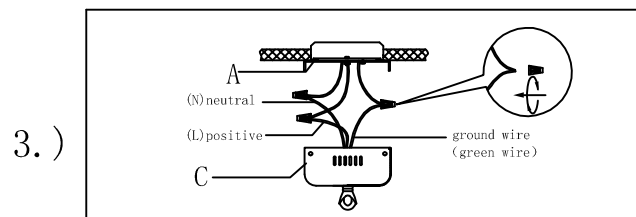

Step. 3: Wire fixture to wires in outlet box. Copper/Green wire is for ground.

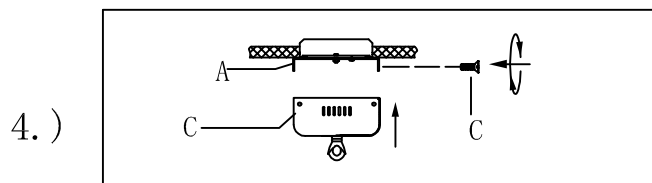

Step. 4: Install fixture to bracket (A) and tighten ball nuts (B) on the backplate to secure.

Cleaning & Care:

Clean with soft cloth and a mild detergent.
Do not use abrasive cleaner.

IMPORTANT: Turn off power at the main fuse or circuit breaker box before starting installation



(F) Part

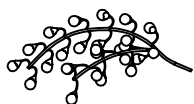

(G) Part

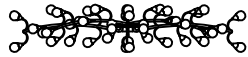

(H) Part



(I) Finial



(J) Bulb

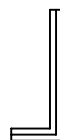

(K) Hexagon wrench

Locate all hardware & components before discarding packaging

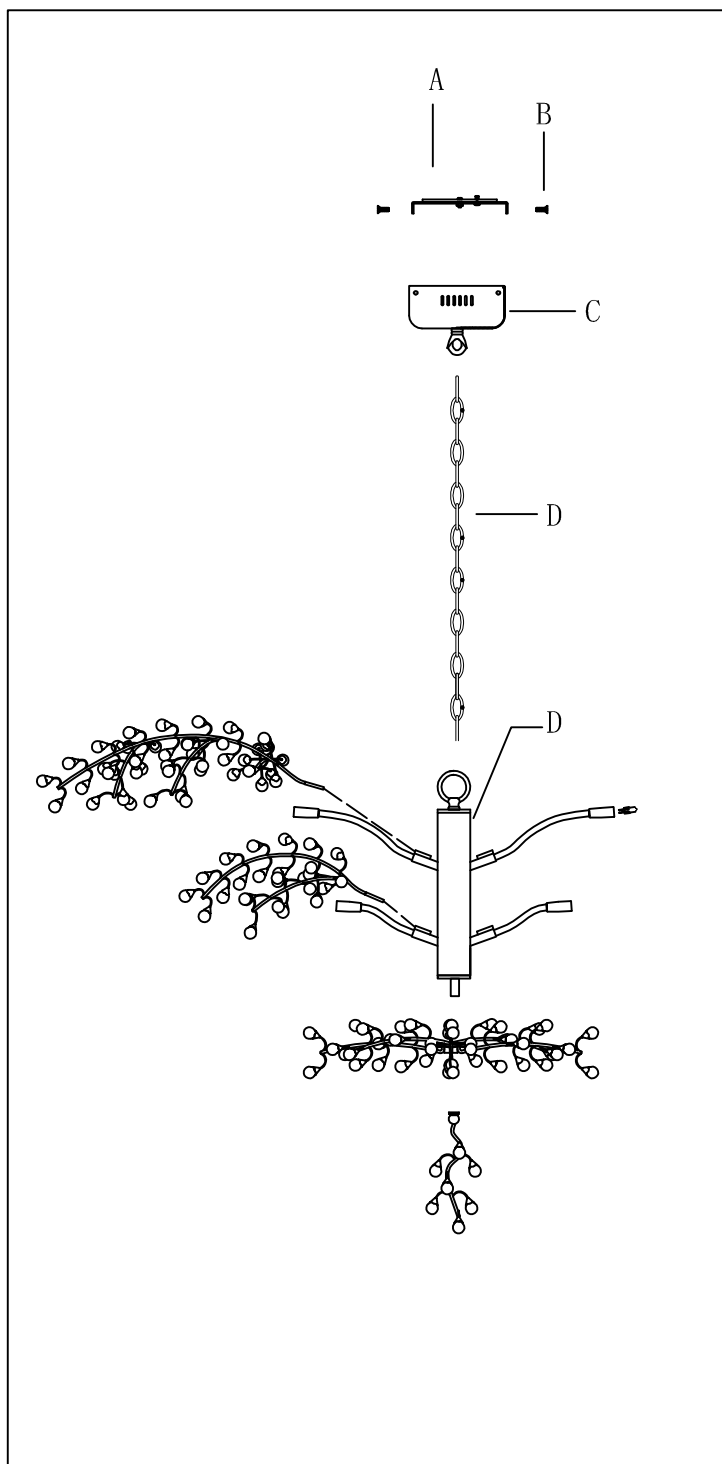

5.)

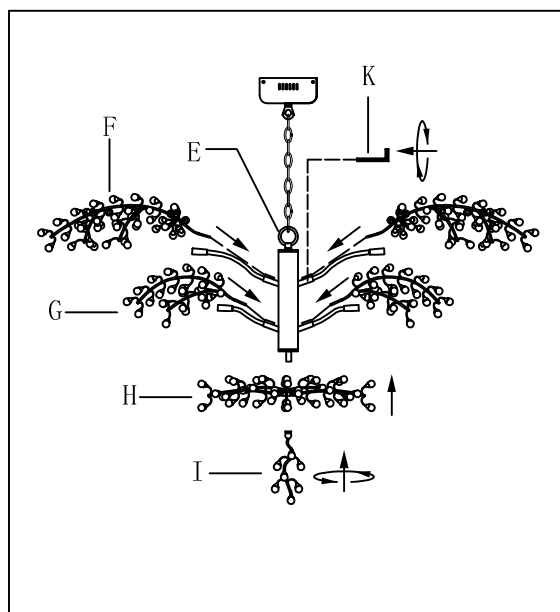

Step. 5: Install Part (F) into the mounting hole which on the top layer of each arm, then install part (G) on the bottom layer of each arm, and use hexagon wrench (I) to secure part (F), part (G) on the body (D). At last use finial (I) to secure part (H) on body (E).

6.)

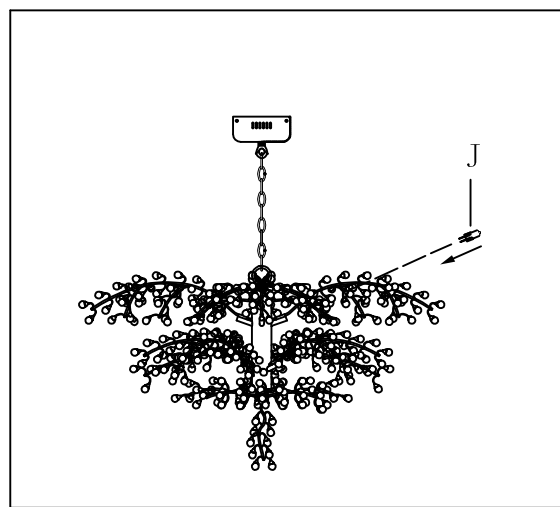

Step. 6: Install the bulb.

Cleaning & Care:

Clean with soft cloth and a mild detergent.
Do not use abrasive cleaner.