

#### Features

- Six Flexjet® hydromassage jets can be individually adjusted for water flow and direction.
- Built-in heater.
- Generous 72" length provides spacious bathing for up to two people.
- Integral lumbar support.
- Multiple pump location options give you more choices for installation and access. (See specification sheet for pump locations.)
- Textured bottom surface.
- Single-speed whirlpool offers performance and value, with 6 fully adjustable jets.

#### Material

- KOHLER® enameled cast iron.

#### Installation

- Drop-in or undermount.
- Reversible drain.

#### Required Products/Accessories

K-9696 Whirlpool 6-Jet Trim Kit

or

K-23856 1-1/2" cable pop-up bath drain

or

K-23857 Bath drain trim

#### Recommended Products/Accessories

K-1179 Vinyl Tiling-in Bead

K-582 Under-Mount Installation Kit

K-9498 3" Keypad Trim

K-23726 Drain treatment

K-23725 Cast iron cleaner



ADA

#### Codes/Standards

ASME A112.19.1/CSA B45.2  
ASME A112.19.7/CSA B45.10  
ASTM F462  
UL 1795  
CSA C22.2 No. 218.2  
ADA  
ICC/ANSI A117.1

#### KOHLER® Hydrotherapy Components Five-Year Limited Warranty





#### KOHLER® Enameled Cast Iron Bath and Shower Base Lifetime Limited Warranty

See website for detailed warranty information.

#### Available Colors/Finishes

*Color tiles intended for reference only.*

Color	Code	Description
-------	------	-------------

	0	White
	96	Biscuit
	NY	Dune
	7	Black Black™

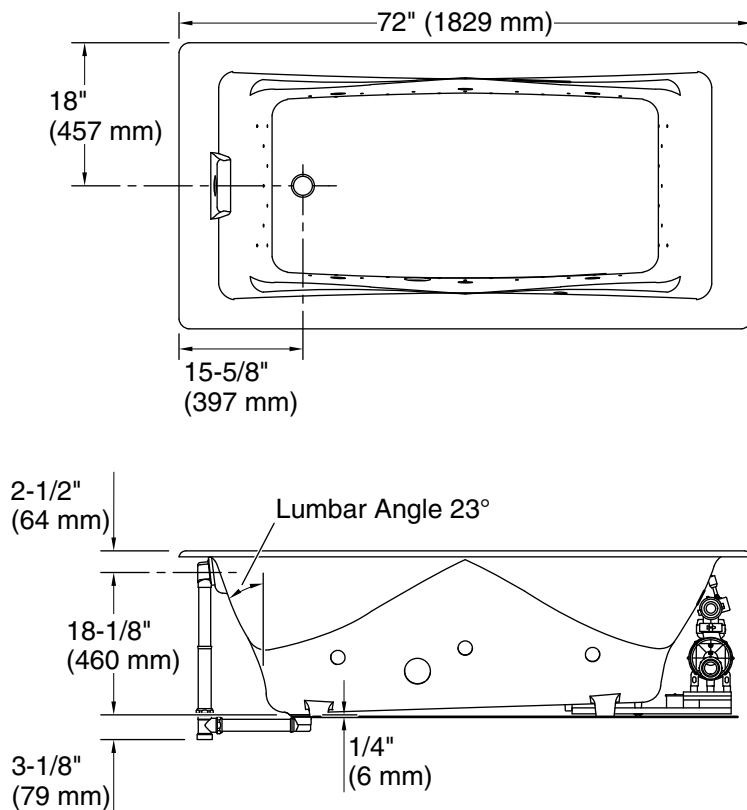

No change in measurements if connected with drain illustrated. (K-7169AF)

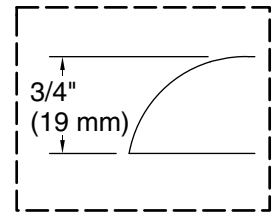

Drop-in Rim Detail

Blower Motor Access

20" (508 mm) W x 15" (381 mm) H Min

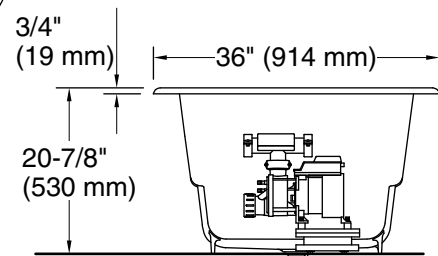

1-1/2" Bath Drain

### Required Electrical Service

Two dedicated circuits required, protected with Class A Ground-Fault Circuit-Interrupter (GFCI). Outside North America, this device may be known as a Residual Current Device (RCD).

Pump: 120 V, 15 A, 60 Hz  
 Heater: 120 V, 15 A, 60 Hz

### Technical Information

All product dimensions are nominal.

Installation: Drop-in, Undermount  
 Drain location: Reversible  
 Basin area, bottom: 49" x 22" (1245 mm x 559 mm)  
 Basin area, top: 62" x 28" (1575 mm x 711 mm)  
 Weight: 455 lbs (206.4 kg)  
 Minimum floor load: 69 lbs/ft<sup>2</sup> (336.9 kg/m<sup>2</sup>)  
 Water depth: 17" (432 mm)  
 Water capacity: 89 gal (336.9 L)  
 Cutout: Drop-in, 70-1/4" x 34-1/2" (1784 mm x 876 mm)  
 Electrical component rating: Pump: 120 V, 7 A, 60 Hz  
 Heater: 120 V, 12 A, 60 Hz  
 Pump speed: Single

### Notes

Measure your actual product for rough-in details. Install this product according to the installation instructions.

The hot water supply should be 70% of the capacity of the bath or greater. Installations will vary.

ADA compliant when installed to the specific requirements of these regulations.