

LIVING DISTRIC T

Collection:Phineas











Installation manual for:

LD7012BR W36"*H8.4"*E5.8"L4

Installation instructions:

1. Black wire from ceiling(junction box) attaches to "L"wire from the fixture.
2. White wire from ceiling(junction box) attaches to "N"wire from the fixture.
3. "E" wire from the fixture is attached to the mounting bracket and an additional "E" wire from the mounting bracket must be secured to the junction box.
4. Secure mounting bracket to the junction box.
5. Insert screws (P2) in side of top unit the mounting bracket(P1).
6. Lock the lamp body on the mounting bracket (P1) on the wall with a flat head screw (P3)
7. Hang Crystal(P11)
8. Install E12 light source.(Bulbs not supplied)
The end!

PARTS LIST

Part	Picture	Description	Qty	Check list
P1		U-shaped hanging board (L4.53**W4.33**H0.59")	1	
P2		Mounting bracket screw	2	
P3		Flat head Screw	4	
P4		Square box (L4.8**H4.8**H0.8")	1	
P5		Double head tube (Ø0.37**L3.03")	2	
P6		Square tube (0.59**1.18**T1.0**L34.06")	1	
P7		Cylindrical iron (Ø0.56**H0.31")	6	
P8		Anti-edge light cup (Ø1.57**H1.57")	4	
P9		E12 card type full1 tooth lamp head	4	
P10		Flat iron frame (L3.93**W3.93**H0.28")	4	
P11		Octagonal heads	96	

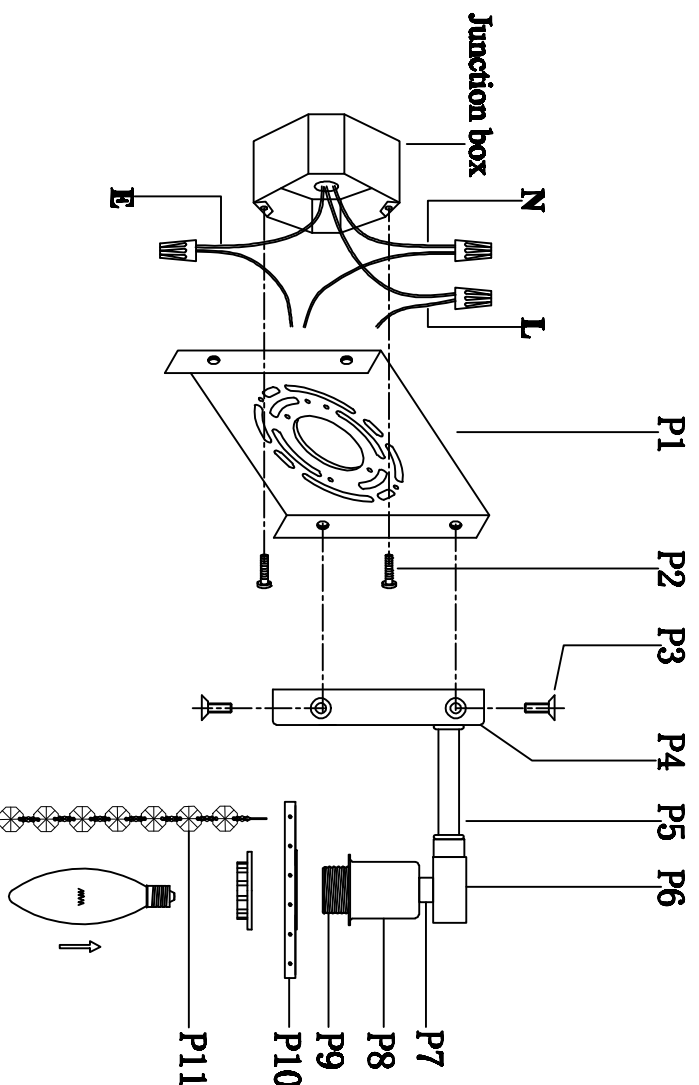

"L" = Hot wire

"N" = Neutral wire

"E" = Ground wire