

9601W5
D5"H11.5"L1

We are dedicated to providing the finest quality crystal chandelier for our customers. Our master craftsmen and designer pride themselves on their attention to detail.

prompt, efficient service is our priority.

Enclosed, are detailed instructions on how to properly install your chandelier. Please read all instructions carefully and thoroughly. If you have any questions please feel free to call our toll free CHANDELIER HOTLINE AT:

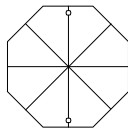

1-888-388-3390



WARNING!!!

**CONTENTS ARE FRAGILE
HANDLE WITH CARE**

The metal frame and crystal components of this chandelier are very delicate. Please exercise extreme caution during unpacking and installation.

WARNING!!!

After passing the main electrical wire through the 10mm pipe and connecting the pipe to the main body top connector, place all remaining pieces as shown in numerical order and in the orientation depicted. Refer to the parts list to avoid confusion between parts. The part numbers coincide.

CAUTION

1. Rated 110-130V/60Hz, bulb 40W maximum
2. Care should be taken to avoid damage to the surface of lighting and wire, wearing gloves is recommended when installing.
3. Connect black or red wire of the lighting to live wire and white or blue wire to neutral wire and double colored (or bare copper) wire to ground wire.
4. Never install lighting on damp ceiling, the room should be dry and well ventilated.
5. Keep lighting away from acid, alkali and other corrosive chemical or gas, clean the lighting with clean soft cloth only.
6. Installation must be carried out by qualified electrician only.
7. Disconnect the power before installing, cleaning and replacing lighting.
8. Never cover the lighting when power is connected.
9. Firmness must be secured when installing ceiling tube, chain, pipe and other connecting parts.
10. Care should be taken to avoid damage when installing glass parts.
11. All electrical components must be installed by a licensed electrician and in accordance with the National Electrical Code and the appropriate local electrical codes. Make sure that the electrical supply to the chandelier is turned off at the main fuse or circuit breaker before doing any installation.

Crystal Dressing Instructions

When dressing the chandelier with the crystals please remember to wear either rubber or cotton gloves. So as to prevent any damage or smudging on the crystals.



A

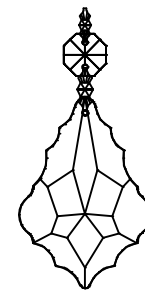

14mm*1pcs

2"*1pcs

No	Quantity
A	8 strings
B	
C	
D	
E	

9601W5 D5"H11.5"L1

Crystal Dressing Diagram



When dressing the chandelier with the crystals please remember to wear either rubber or cotton gloves. So as to prevent any damage or smudging on the crystals.

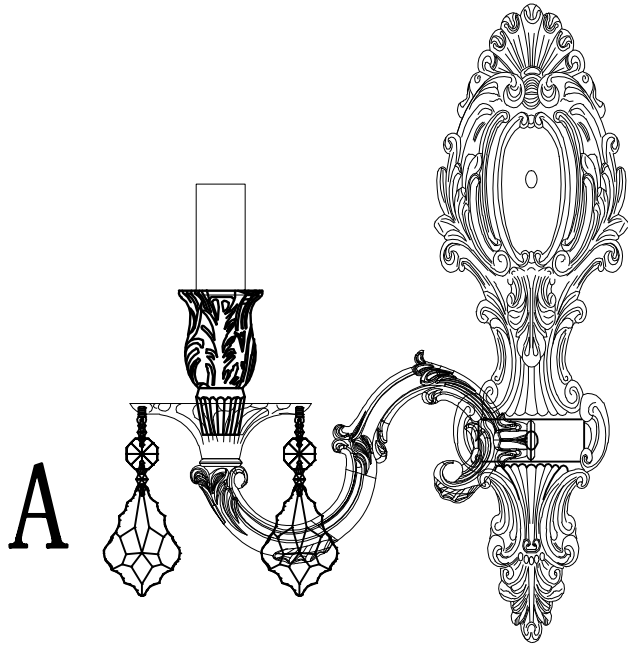

09

9601W5 D5"H11.5"L1

CANOPY PARTS LIST

ZA:Existing Electrical Box (not supplied)

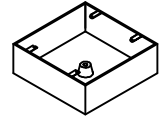

ZB:Crossbar



ZC:Crossbar Screws x 2(not supplied)

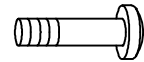

ZD:Wall Lamp Bass

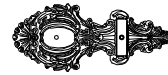

ZE:Crossbar Bracket



ZF:Ground Wire



ZG:Junction Caps



02

9601W5 D5"H11.5"L1

Canopy Installation Diagram

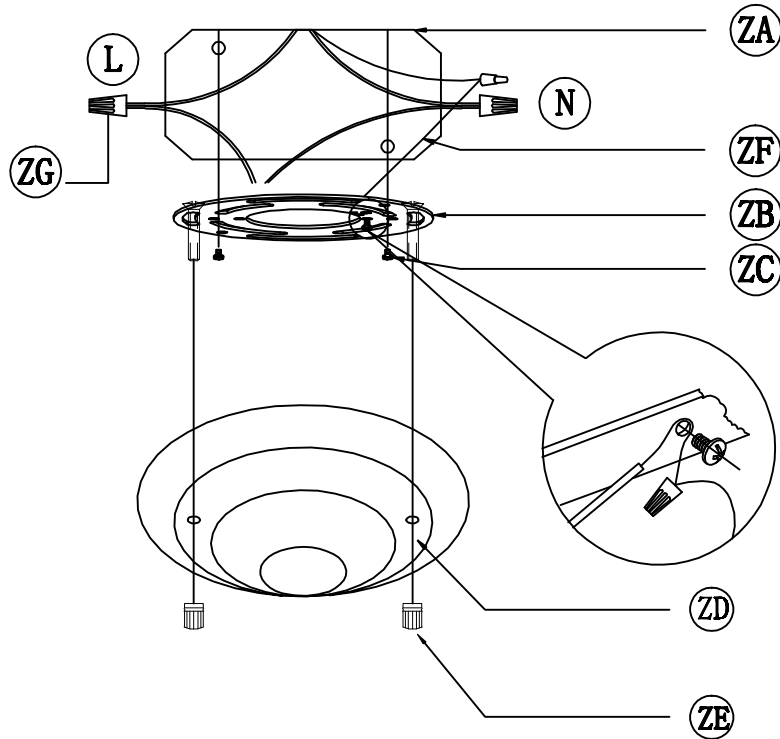

03

9601W5 D5"H11.5"L1

Frame Assembly Instructions

Please read all instructions carefully. Before you proceed to install, make sure that the power supply is turned off and off until installation is complete. Please note that each part has been assigned a letter. Please proceed in alphabetical order.

- 1 . Install (Round Crossbar)01 to the electric Box and wire properly.
- 2 . using (Crossbar Bracket)02, attach (Cast Column Cover)03 to ceiling.
- 3 . Dressing Crystal using Diagram provided.

The end!

08

WARNING!!!

CONTENTS ARE FRAGILE HANDLE WITH CARE

The metal frame and crystal components of this chandelier are very delicate. Please exercise extreme caution during unpacking and installation.

WARNING!!!

After passing the main electrical wire through the 10mm pipe and connecting the pipe to the main body top connector, place all remaining pieces as shown in numerical order and in the orientation depicted. Refer to the parts list to avoid confusion between parts. The part numbers coincide.

CAUTION

1. Rated 110-130V/60Hz, bulb 40W maximum
2. Care should be taken to avoid damage to the surface of lighting and wire, wearing gloves is recommended when installing.
3. Connect black or red wire of the lighting to live wire and white or blue wire to neutral wire and double colored (or bare copper) wire to ground wire.
4. Never install lighting on damp ceiling, the room should be dry and well ventilated.
5. Keep lighting away from acid, alkali and other corrosive chemical or gas, clean the lighting with clean soft cloth only.
6. Installation must be carried out by qualified electrician only.
7. Disconnect the power before installing, cleaning and replacing lighting.
8. Never cover the lighting when power is connected.
9. Firmness must be secured when installing ceiling tube, chain, pipe and other connecting parts.
10. Care should be taken to avoid damage when installing glass parts.
11. All electrical components must be installed by a licensed electrician and in accordance with the National Electrical Code and the appropriate local electrical codes. Make sure that the electrical supply to the chandelier is turned off at the main fuse or circuit breaker before doing any installation.

Canopy Installation Instructions

Please read all instructions carefully. Before you proceed to install, make sure that the power supply is tamed off and off until installation is complete. Please note that each part has been assigned a letter. Please proceed in alphabetical order.

- ZA. Junction Box (not supplied)
- ZB. Crossbar
- ZC. Crossbar Screws (not supplied)
- ZD. Wall Lamp Bass
- ZE. Crossbar Bracket
- ZF. Ground Wire
- ZG. Junction Caps

1. Attach the Crossbar (ZB) to the Junction Box (ZA) using the two crossbar screws (ZC) which are not supplied and should already be in your box.
2. Be sure when connecting the wire use electrician approved junction caps (ZG).
3. Stow the excess wire in the junction box (ZA).
4. Crossbar Bracket (ZE), attach Wall Lamp Bass (ZD) to ceiling.

9601W5 D5"H11.5"L1

Frame Assembly Diagram

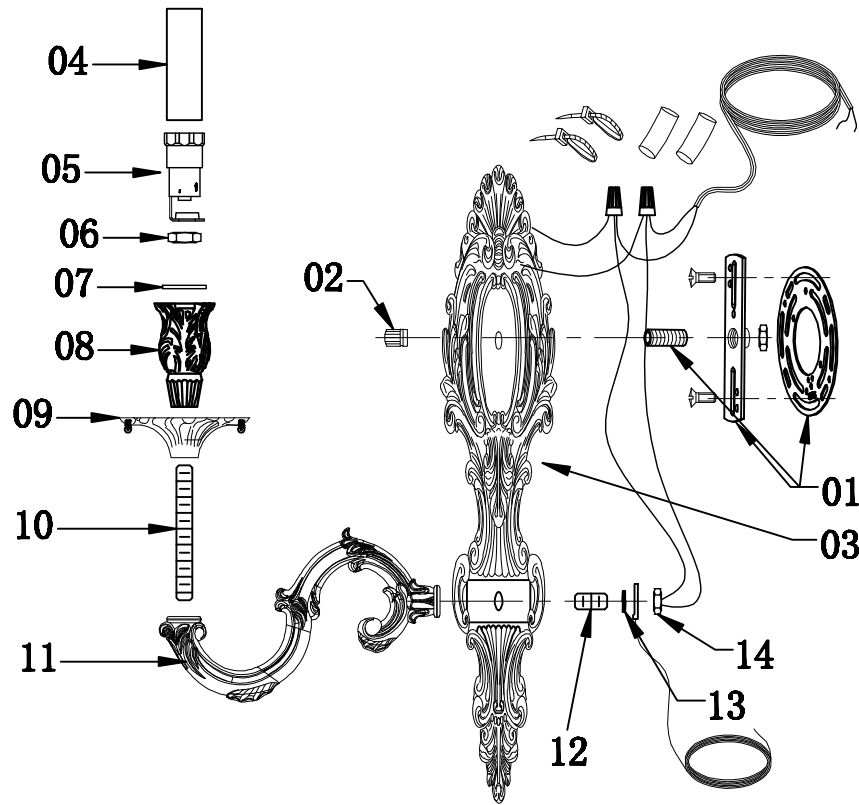

05

9601W5 D5"H11.5"L1

Fram Parts List



01-Round Crossbar



06-Set Screw



11-Cast Arm



02-Crossbar Bracket



07-Washer



12-All thread



03-Wall Lamp Bass



08-Cast Socket



13-Spring Seat



04-Sleeve Cover



09-Cast Bobeche



14-Set Screw



05-Socket



10-All thread

06