



ELEGANT

FURNITURE & LIGHTING™

## Installation manual for:

2803G120

Dimensions:D96" H120" L84  
Collection: Maria Theresa  
Bulb Type:E12 bulb not included  
Lamp Frame Weight(lbs):263.6  
Total Weight(lbs):420



Thank you for choosing our product(s).  
Our Company is actively involved in every step of the production.  
Our product(s) are designed to be utilized for every application that graces your home or business.  
We pride ourselves in providing the most prompt and courtesy service to all of the valued customers.  
Please find the enclosed detailed instruction and read carefully for proper installation.  
If you have any questions, please contact the retailer where the purchased was made.

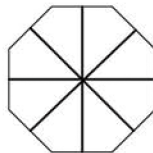

**SAFETY**

Warning: MAKE SURE THE ELECTRICITY TO THE WIRES YOU ARE WORKING ON IS SHUT OFF. BY EITHER REMOVING THE FUSE OR TURNING OFF THE CIRCUIT BREAKER.

**CAUTION**

- Before assembling the lighting fixture, please read all instructions carefully.
- All frame & crystal components are fragile, please handle with care.
- Required supply circuit : 110 - 130V/60Hz
- Labeled wires are "L" for live wire, "N" for neutral wire, "E" for ground wire.
- Never install fixture on damp ceiling, the room should be dry and well ventilated
- All electrical components must be installed by a licensed electrician and in accordance with the National Electrical Code and the appropriate local electrical codes.

**Unpack the Package**

Please open the box carefully and check all the items are inside the box. If you have any installation, assembling and missing parts questions, where you purchase from and any other relevant information ready, our customer service team will provide comprehensive and worry free service to our valued customers.

**Frame Parts List**

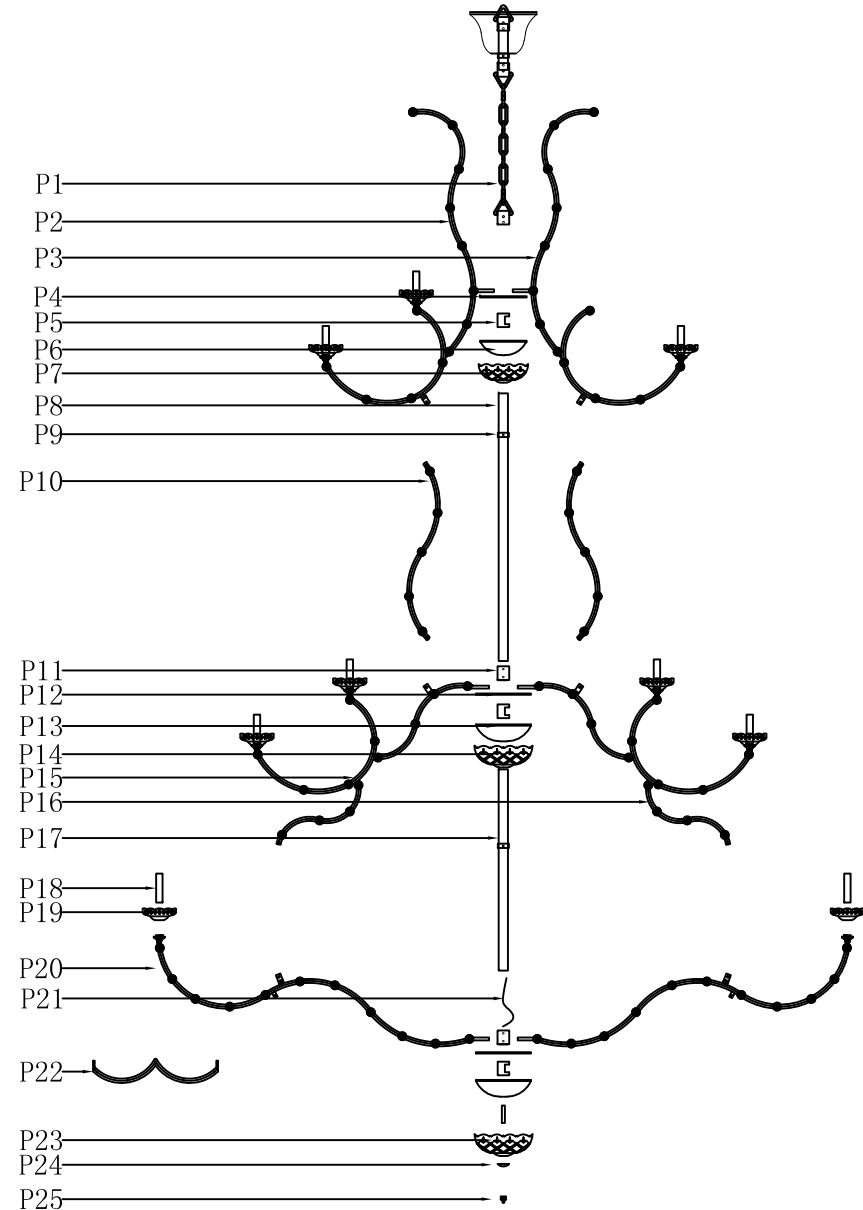















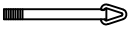

2803G120 D96" H120" L84

# Step 1

Please use the parts list to ensure you are not missing any parts



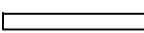











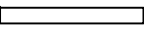

2803G120

## PARTS LIST

part	picture	Description	Parts Number	Qty	Check list
ZA		4"Crossbar	CP1032R98C CP1032R98G	1	
ZA		Crossbar		1	
ZB		φ9.8"Canopy		1	
ZC		Canopy ring		1	
ZD		ROD1032	ROD1032C ROD1032G	1	
ZE		L59"Chain10P Plain Design	Chain10PCH Chain10PGD	1	
ZF		Power Cord 12' SPT-2-16# Clear/Gold		3	
P1		Loop		1	
P2		glass arm 40"	ARM10280040C ARM10280040G	7	
P3		glass arm 40"	ARM102800A40C ARM102800A40G	7	
P4		6" Metal plate		1	
P5		Hickey		3	
P6		6"Metal bowl		1	
P7		7"Glass dish	GD1007J70CL	1	
P8		Metal ring		2	
P9		36.6"Both end threaded pipe		1	
P10		Glass arm 24" connection	ARM10280024C ARM10280024G	14	



















03

2803G120 D96" H120" L84











part	picture	Description	Parts Number	Qty	Check list
P11		Coupling	/	2	
P12		7.5"Metal plate		2	
P13		7.5"Metal bowl		2	
P14		7.8"Glass dish		GD1007J78CL GD1007J78GT	1
P15		Glass arm 32"	ARM102800A32C ARM102800A32G	7	
P16		Glass arm 32"	ARM10280032C ARM10280032G	7	
P17		26.7"Both end threaded pipe	/	1	
P18		4"Metal tube		84	
P19		4.5"Glass dish	GD1003G45CL	84	
P20		Glass arm 45"	ARM10280045C ARM10280045G	14	
P21		Steel wire		1	
P22		Glass arm 13" connection	ARM10280013C ARM10280013G	14	
P23		7.8"Glass dish	GD1007A78CL GD1007A78GT	1	
P24		washer	/	1	
P25		Finial		1	
A		1050-14#*3+872-3.0"		14	
B		1050-14#*1+872-2.0"		420	
C		1050-14#*3+872-3.0"		14	
D		1050-14#*10+872-3.0"	14		

04

2803G120 D96" H120" L84

part	picture	Description	Parts Number	Qty	Check list
E		1050-14#*7+872-3.0"	/	14	
F		1050-14#*10+872-3.0"		14	
G		1050-14#*5+872-3.0"		28	
H		1050-14#*3+872-3.0"		14	
I		1050-14#*3+872-3.0"		21	
J		1050-14#*17+872-3.5"		28	
K		1050-14#*10+872-3.5"		28	
L		1050-14#*12+872-3.5"		28	
M		1050-14#*16+872-3.5"		28	
N		1050-14#*22+872-3.5"		14	
O		1050-14#*24+872-3.5"		14	
P		1050-14#*23+872-3.5"		14	
Q		1050-14#*21+872-3.5"		14	
R		1050-14#*22+872-3.5"		14	
S		1050-14#*28+872-3.5"		14	
T		1050-14#*27+701-50#		1	
U		1050-14#*8+1053-14#*1+1050-14#*8+1050-14#*17+872-3.0"		14	
V		1050-14#*8+1053-14#*1+1050-14#*8+1050-14#*19+872-3.0"		14	
W		1050-14#*11+1053-14#*1+1050-14#*11+1050-14#*13+872-3.0"		14	

2803G120 D96" H120" L84

part	picture	Description	Parts Number	Qty	Check list	
X		1050-14#*10+1053-14#*1+1050-14#*10+1050-14#*10+872-3.0"	/	14		
Y		1050-14#*9+1053-14#*1+1050-14#*9+1050-14#*6+872-3.0"		14		
Z		1050-14#*8+1053-14#*1+1050-14#*8+1050-14#*4+872-3.0"		14		
Z1		1050-14#*7+1053-14#*1+1050-14#*7+1050-14#*9+872-3.0"		28		
Z2		1050-14#*7+1053-14#*1+1050-14#*7+1050-14#*1+872-3.0"		21		
Z3		1050-14#*6+1053-14#*1+1050-14#*6+1050-14#*1+872-3.0"		14		
Z4		1050-14#*8+1053-14#*1+1050-14#*8+1050-14#*2+872-3.0"		14		
Z5		1050-14#*6+1053-14#*1+1050-14#*6+1050-14#*1+872-3.0"		14		
Z6		1050-14#*6		14		
Z7		1050-14#*8		14		

## step 2

## Canopy Installation Instruction

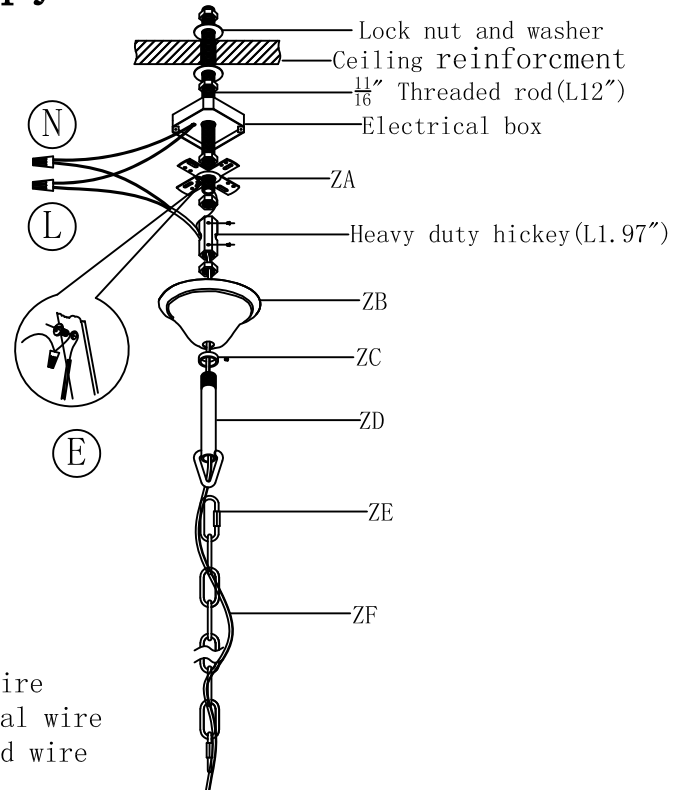

"L" = Hot wire  
 "N" = Neutral wire  
 "E" = Ground wire

IMPORTANT: Test sockets with bulb before dressing the fixture.

1. Drill a  $\phi 0.7$ " hole in the ceiling reinforcement to allow a  $\frac{1}{16}$ " threaded rod to pass through.
2. Attach the electrical box to the ceiling reinforcement and pass the  $\frac{1}{16}$ " threaded rod through the box and secure it to the heavy duty hickey.
3. Pass the fixture wires and ground wire through the loop, canopy ring, center hole of canopy and the heavy duty hickey.
4. Pull ceiling wires down through the fixture box and make connection.
5. Screw loop only onto threaded pipe.
6. Hang the fixture on chain.
7. Secure the canopy with canopy ring.

07

## Canopy Installation Instruction

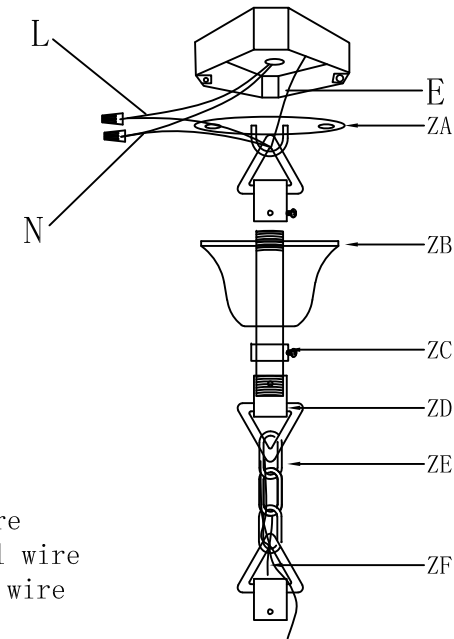

"L" = Hot wire  
 "N" = Neutral wire  
 "E" = Ground wire

Please read all instructions carefully. Before you proceed to install, make sure that the power supply is turned off and off until installation is complete. Please note that each part has been assigned a letter. Please proceed in alphabetical order.

1. Fix the crossbar (ZA) to the ceiling with the two crossbar screws.
2. Hang the Canopy ring (ZC) back up over the canopy (ZB), through metal rod (ZD) together.
3. Hang the electric main and ground wire through the chain (ZE), the Metal rod (ZD), the Loop and the crossbar (ZA) until the end of the electric main reaches the junction box where you can make the appropriate connections.
4. Be sure when connecting the wire use electrician approved junction caps.
5. Stow the excess wire in the junction box (ZA).
6. Raise the canopy (ZB).
7. Canopy ring (ZC), attach canopy (ZB) to ceiling, slide metal ring (ZC) over canopy lock (ZD) and hold the canopy (ZB).

08

# Frame Assembly Diagram

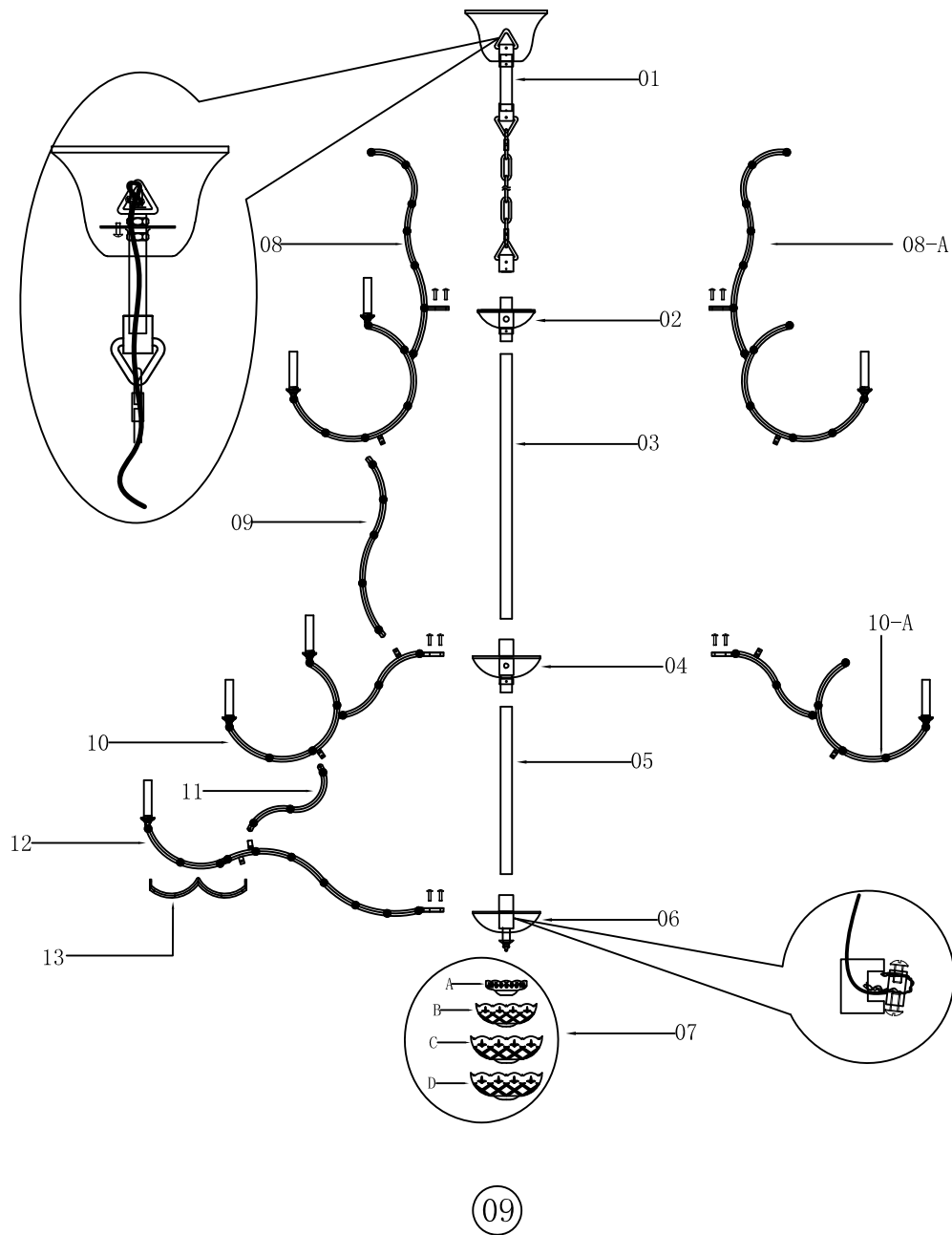

## Step 3

# Frame Assembly Instructions

### Installation:

Please read all instructions carefully.  
 Before you proceed to install, make sure  
 that the power supply is turned off and  
 remains off until installation is complete.  
 Please note that each part has been assigned a number.  
 Please proceed in a numerical order.

1. Hang the chain (01) on the ceiling.
2. Unscrew the lamp body (02), fix the glass arm (08) and the glass arm (14) into the lamp body (02) pressing holes, screw them well with M5\*18mm screws, put the positive and negative wire into the lamp body (02) pressing holes connect with the main wire, cover the glass dish (07-B) on the lamp body (02) bottom, then screw well lamp body (02).
3. Screw the threaded pipe (03) on the lamp body (02) bottom, screw the glass arm (09) on the glass arm (08) bottom with M4\*14# screws.
4. Unscrew the lamp body (04), fix the glass arm (10) and the glass arm (15) into the lamp body (04) pressing holes, screw them well with M5\*18mm screws, put the positive and negative wire into the lamp body (04) pressing holes connect with the main wire, cover the glass dish (07-C) on the lamp body (04) bottom, then screw well lamp body (04).
5. Screw the threaded pipe (05) on the lamp body (04) bottom, screw the glass arm (11) on the glass arm (10) and on the glass arm (15) bottom with M4\*14# screws.
6. Unscrew the lamp body (06), fix the glass arm (12) into the lamp body (06) pressing holes, screw them well with M5\*18mm screws, put the positive and negative wire into the lamp body (06) pressing holes connect with the main wire, cover the glass dish (07-D) on the lamp body (06) bottom, then screw well lamp body (06).
7. Screw the glass arm (13) on the glass arm (12) bottom with M4\*14# screws.
8. Hang the all lamp on the chain (01) bottom ring.
9. Put the metal tube through the central hole in the glass dish (07-A) and place the glass plate on the fixer under.
10. Pull up the steel wire through the lamp body and fix it.
11. As the crystal dressing instruction, hang the crystal parts.

NOTE: The fixture have the steel wire, you can't cut it, please use the steel wire and pull up it to the canopy to fix the fixture.

## Step 4 Crystal Dressing Instructions

1. Hang crystal "A", "B", "C", "D", "E", "F", "G", "H", "I", "J", "K", "L", "M", "N", "O", "P", "Q", "R", "S", "T".
2. Connect both ends of Z7 with A  
 Connect both ends of Z6 with C  
 Connect both ends of Z5 with F  
 Connect both ends of Z4 with E  
 Connect both ends of Z3 with H  
 Connect both ends of Z2 with I  
 Connect both ends of Z1 with J  
 Connect both ends of Z with K  
 Connect both ends of Y with L  
 Connect both ends of X with M  
 Connect both ends of W with N  
 Connect both ends of V with O  
 Connect both ends of U with P

## Crystal Dressing Diagram

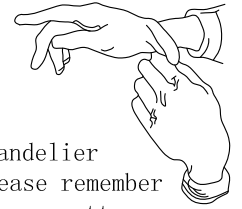

When dressing the chandelier with the crystals please remember to wear either rubber or cotton gloves. So as to prevent any damage or smudging on the crystals.

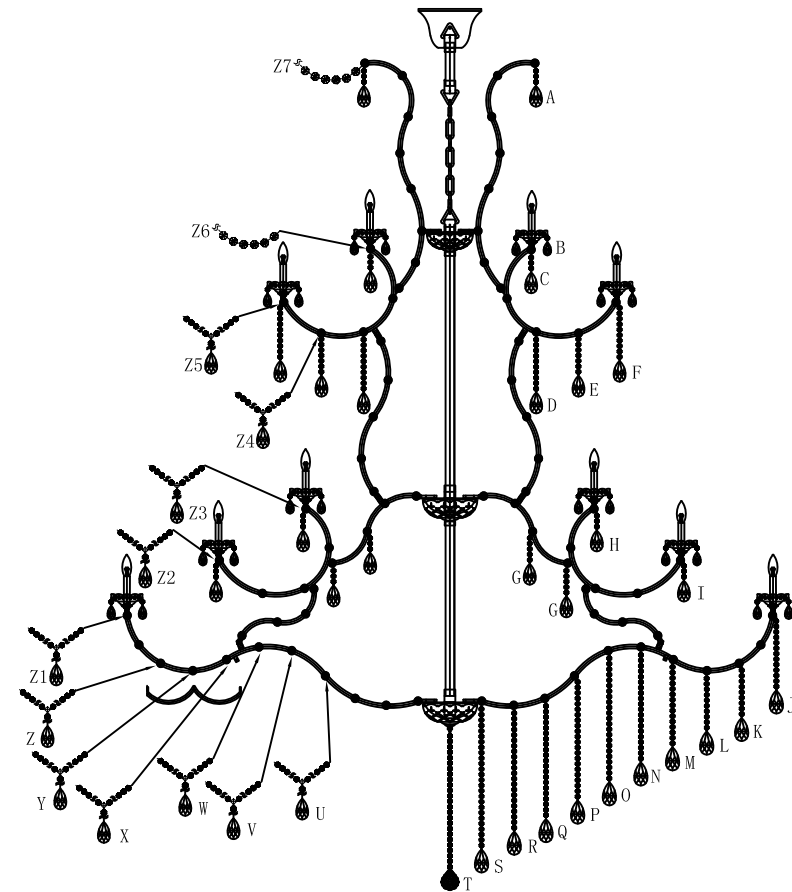

## Congratulations !

You are now done installing your Elegant Lighting fixture. Sit back and admire each crystal as it will become the statement piece for your room/house.

Thank you.

### **Cleaning and Maintenance of Chandelier Frame**

The finish on our chandelier frames and fixture frames is protected by a durable coating of lacquer. To clean, use a clean soft, dry cloth. Do not use any metal polishes, cleaners, abrasives or any substance which could remove the protective finish. Failure to follow these instructions automatically voids the guarantee.

### **Cleaning and Maintenance of Crystals**

Wet a soft cotton fabric in clean warm water and wipe gently, then polish with a dry soft cotton fabric.

### **To Order Crystal Replacement Parts**

Should you require replacement crystals or pins (the metal connectors attaching the crystals), contact the store where the product was purchased. For ease of ordering, you may use the original crystal trimming instructions provided with this product and circle the items you wish to order, indicating the quantity by writing the number needed adjacent to the circle. You will be contacted with prices prior to shipment. All orders must be pre-paid.



## Elegant Lighting Warranty

The finish and frame of your new chandelier or fixture are warranted for a period of one (1) year from the date of purchase. Our company will, at its option, repair or replace any frame that has a defect in the materials or workmanship during the warranty period. All crystals are guaranteed for their original quality during the life of the chandelier. Breakage is not covered by this warranty.

To make a claim under this warranty, contact our customer service department.

A written return authorization form will be sent to you with specific instructions.

## Returns and Conditions of Warranty

Returns must be pre-authorized by contacting the retailer where you made your purchase..Returns will only be accepted with a written return merchandise authorization and return shipping charges pre-paid. We reserve the right to inspect all returned merchandise to fully determine the nature of any defect. This guarantee shall not apply to any product that has been changed, altered or otherwise modified, nor shall it apply to any product that has been repaired or altered by anyone other than a pre-authorized facility. We will not be responsible for any breakage or damages incurred during transit, nor for crystal parts or metal frame part that have been subject to misuse, negligence, accident or inappropriate handling. Also, we will not be held responsible for damage incurred during improper installation or wiring by others, nor for damages resulting from a failure to follow the recommended maintenance or installation procedures. This guarantee is issued in lieu of any and all other guaranteed or warranty, whether written or implied and any and all other obligations or liabilities. Further, we neither authorize nor permit any other person or firm to assume for us, any liability in connection with the sale of our products.