

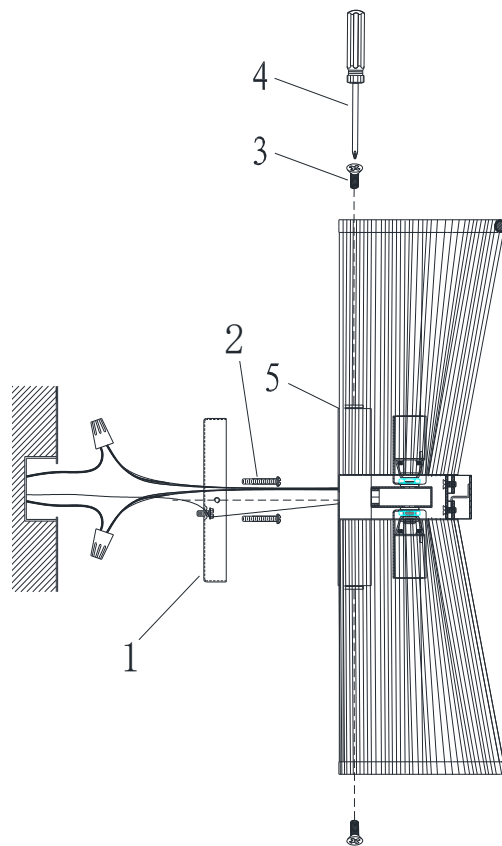

ASSEMBLY AND INSTALLATION INSTRUCTIONS for the **641221** Fixture

Important Safety information (Please read before proceeding)

1. Remove the fixture, parts and all mounting hardware bags (orange) from the carton and verify that all parts are present according to the illustration sheet. All parts must be used as indicated. Do not replace any parts, leave any parts out, or use any parts which are worn out or broken. **Failure to follow the instructions could cause a hazardous situation, voids the warranty and violates the U.L. listing of the fixture.**
2. To prevent the electric shock, turn off the main power at the circuit breaker before installing the fixture. **NEVER attempt to install, clean or replace bulbs without shutting off the electricity to the fixture.**
3. **Never use light bulbs with wattage ratings that exceed the fixtures maximum rating.** Always make sure the electric current is turned off before changing the bulbs.
4. If you experience difficulties installing the lighting fixture or it fails to work as expected, please contact a local qualified licensed electrical contractor.
5. Please contact your local Capital Lighting Fixture reseller with any assembly or installation questions. Your local reseller can also provide you with replacement parts for your new fixture.



Components

1. Mounting Bracket w/Green Screw
2. Outlet Box Mounting Screws
3. Mounting Screws
4. Philips Screw Driver (not provided)
5. Fixture

Assembly Instructions for the 641221 fixture

1. Attach Mounting Bracket (1) to Outlet Box with Outlet Box Mounting Screws (2), make sure the mounting holes in both tabs vertically.
2. Raise Fixture (5) toward outlet box, then connect fixture ground wire to outlet box ground wire with wire connector supplied; connect white fixture wire to the white power supply wire with wire connector supplied; connect black fixture wire to the black power supply wire with wire connector supplied.
3. Push Canopy of Fixture (5) to mounting surface, make sure mounting holes in Canopy of Fixture (5) and Mounting Bracket (1) are in line, verify all wires are securely inside Canopy of Fixture (5) and Mounting Bracket (1), and carefully passing Mounting Screws (3) through holes, then secure Canopy of Fixture (5) to mounting surface with Mounting Screws (3) and Philips Screw Driver (not provided) (4).